

Sicherheitshinweise, die unbedingt beachtet werden müssen, sind in dieser Anleitung mit folgendenden Symbolen markiert:



Geräte dürfen nur fachgerecht entsorgt werden!

Sicherheitshinweise

Universelle Messeinheit für Starkstromgrößen SINEAX CAM



Camille Bauer Metrawatt AG
Aargauerstrasse 7
CH-5610 Wohlen/Schweiz
Telefon +41 56 618 21 11
Telefax +41 56 618 21 21
info@cbmag.com
www.camillebauer.com



156 449-04

09.14

Erst lesen, dann ...



Der einwandfreie und gefahrlose Betrieb setzt voraus, dass dieser Sicherheitshinweis so wie die Betriebsanleitung (Nr. 156 457) **gelesen** und verstanden wurden!

Der Umgang mit diesem Gerät sollte nur durch entsprechend geschultes Personal erfolgen, das das Gerät kennt und berechtigt ist, Arbeiten in elektrischen Anlagen auszuführen.

Bei einem Eingriff in das Gerät erlischt der Garantieanspruch!

Lieferumfang

SINEAX CAM
1 Sicherheitshinweis
1 Software- und Dokumentations-CD
1 USB-Kabel

Kurzbeschreibung

Die konfigurierbare Messeinheit SINEAX CAM ist für die Messung in elektrischen Wechselstrom-Verteilnetzen oder Industrieanlagen konzipiert. Sie ermittelt zuverlässig den aktuellen Netzzustand und durch eine umfassende Oberwellenanalyse den Grad der Verunreinigung durch nichtlineare Verbraucher.

Das Gerät ist auch für die Erfassung spezieller Eingangssignale mit variablem Messintervall (z.B. Vollwellen-Steuerungen), veränderter Sinus-Form (z.B. Phasenanschnitt-Steuerungen) oder starker Verzerrung geeignet.

Technische Daten

Messeingang →

Spannung: 57...400V (L-N), bzw. 100...693V (L-L)
Strom: 1...5 A
Nennfrequenz: 50/60 Hz
Anschlussarten: Einphasig, 3- oder 4-Leiternetze gleicher oder ungleicher Belastung, Split-Phase, 4-Quadranten-Betrieb

Hilfsenergie →

Option 1: 100...230 V AC/DC ± 15%
Option 2: 24...60 V DC ± 15%
Leistungsaufnahme: ≤ 4...20 VA (je nach I/O-Interface)
Grüne Leuchtdiode: Power-On Anzeige

Schnittstellen ↔

Bus-Anschluss: RS-485 (Modbus-Protokoll), via Steckklemmen, max. Länge 1200 m (4000 ft)
USB-Anschluss: USB 2.0, 5-polig Mini-B

Relais →

Belastbarkeit: 250 V AC, 2 A, 500 VA oder 30 V DC, 2 A, 60 W

I/O-Interface

Je nach Geräteausführung stehen verschiedene Klemmengruppen mit definierter Ein-/Ausgangsfunktion zur Verfügung. Diese Gruppen sind gegeneinander galvanisch getrennt.

Analogausgänge →

2x 0/4...20 mA pro Klemmengruppe, galvanisch verbunden oder
2x ± 20 mA pro Klemmengruppe, galvanisch verbunden
Bürdenspannung 10 V max.
Bürde 0...500 Ω (max. 20 mA)

Analogeingänge →

2x 0/4...20 mA pro Klemmengruppe, galvanisch verbunden
Eingangswiderstand < 40 Ω

Digitalein-/ausgänge →

3 pro Klemmengruppe, softwaremässig als passive Ein- oder Ausgänge konfigurierbar (alle gleich), nach EN 61131-2
Eingänge 24 V DC (Typ 3)
Ausgänge 24 V DC, Nennstrom 50 mA (60 mA max.)

Digitale Eingänge 125 V DC →

3 pro Klemmengruppe
Eingänge 48 / 125 V DC

HV-Input 110 V / 230 V AC →

Spannungsbereich: 0...265 V AC (1,1 x 240 V)
Frequenz: 50...60 Hz
Schaltgrenze: 40...80 V AC
Eingangsimpedanz: 20 ... 30 kΩ

Befestigung

Die Befestigung des Gerätes erfolgt auf einer Hutschiene.



Bei der Festlegung des Montageortes (Messortes) ist zu beachten, dass die **Grenzen** der Betriebstemperatur **nicht überschritten** werden:
- 10 ... 55 °C

Gehäuse auf Hutschiene (EN 50 022) aufschnappen (siehe Bild 1).



Bild 1. Befestigung auf Hutschiene 35 x 15 oder 35 x 7,5 mm.

Demontage-Hinweis

Gehäuse gemäss Bild 2 von der Tragschiene abnehmen.

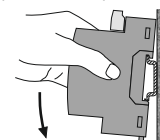

Bild 2

Elektrische Anschlüsse

Die Anschlüsse sind als Schraubklemmen ausgeführt. Sie sind geeignet für eindrähtige Leitungen mit 4 mm² oder mehrdrähtige Leitungen mit 2 x 2,5 mm² Leitungsquerschnitt.

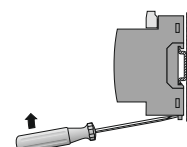

Unbedingt sicherstellen, dass die Leitungen beim Anschliessen spannungsfrei sind!



Es ist zu beachten, ...
... dass die Daten auf dem Typenschild eingehalten werden!

Analogausgänge

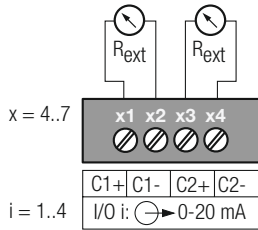

Analogeingänge

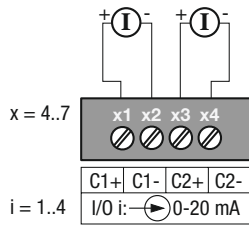

Digitalausgänge

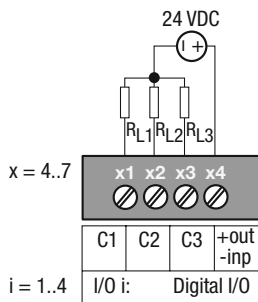

Digitaleingänge

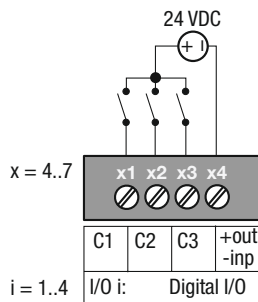

HV-Input 110/230 VAC

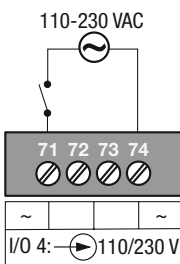

Digitaleingänge 125 V DC

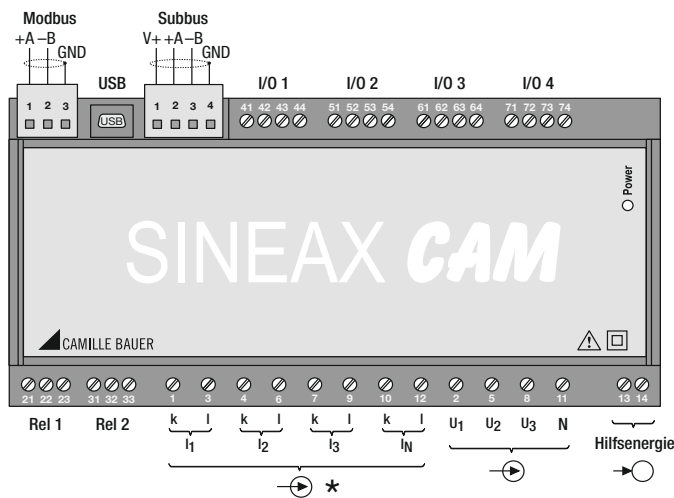
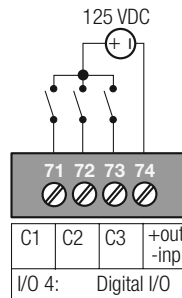

Der Zustand des Relaiskontakts bei ausgeschaltetem Gerät ist nicht definiert. Es können gefährliche Spannungen anliegen.

* Stromeingänge für Rogowski-Spulen:
Siehe Betriebsanleitung auf der CD

Anschlussarten

Netzformen / Anwendung	Klemmenbelegung															
Einphasen-Wechselstromnetz																
Dreileiter-Drehstromnetz gleichbelastet I: L1																
	<p>Bei Strommessung über L2 bzw. L3, Spannungsanschluss nach folgender Tabelle vornehmen:</p> <table border="1"> <thead> <tr> <th>Stromwandler</th> <th>Klemmen</th> <th>2</th> <th>5</th> <th>8</th> </tr> </thead> <tbody> <tr> <td>L2</td> <td>1</td> <td>3</td> <td>L2</td> <td>L3</td> </tr> <tr> <td>L3</td> <td>1</td> <td>3</td> <td>L3</td> <td>L1</td> </tr> </tbody> </table>	Stromwandler	Klemmen	2	5	8	L2	1	3	L2	L3	L3	1	3	L3	L1
Stromwandler	Klemmen	2	5	8												
L2	1	3	L2	L3												
L3	1	3	L3	L1												
Vierleiter-Drehstromnetz gleichbelastet I: L1																
	<p>Bei Strommessung über L2 bzw. L3, Spannungsanschluss nach folgender Tabelle vornehmen:</p> <table border="1"> <thead> <tr> <th>Stromwandler</th> <th>Klemmen</th> <th>2</th> <th>11</th> </tr> </thead> <tbody> <tr> <td>L2</td> <td>1</td> <td>3</td> <td>L2</td> </tr> <tr> <td>L3</td> <td>1</td> <td>3</td> <td>L3</td> </tr> </tbody> </table>	Stromwandler	Klemmen	2	11	L2	1	3	L2	L3	1	3	L3			
Stromwandler	Klemmen	2	11													
L2	1	3	L2													
L3	1	3	L3													

ⓘ Zum Abschalten der Hilfsenergie ist in der Nähe des Gerätes ein gekennzeichnete, leicht erreichbarer Schalter vorzusehen.

Bei einer Gleichstromversorgung > 125 V DC muss im Hilfsenergiekreis eine externe Sicherung vorgesehen werden.

Im übrigen sind die landesüblichen Vorschriften (z.B. für Deutschland VDE 0100 «Bedingungen über das Errichten von Starkstromanlagen mit Nennspannungen unter 1000 V») bei der Installation und Auswahl des Materials der elektrischen Leitungen zu befolgen!

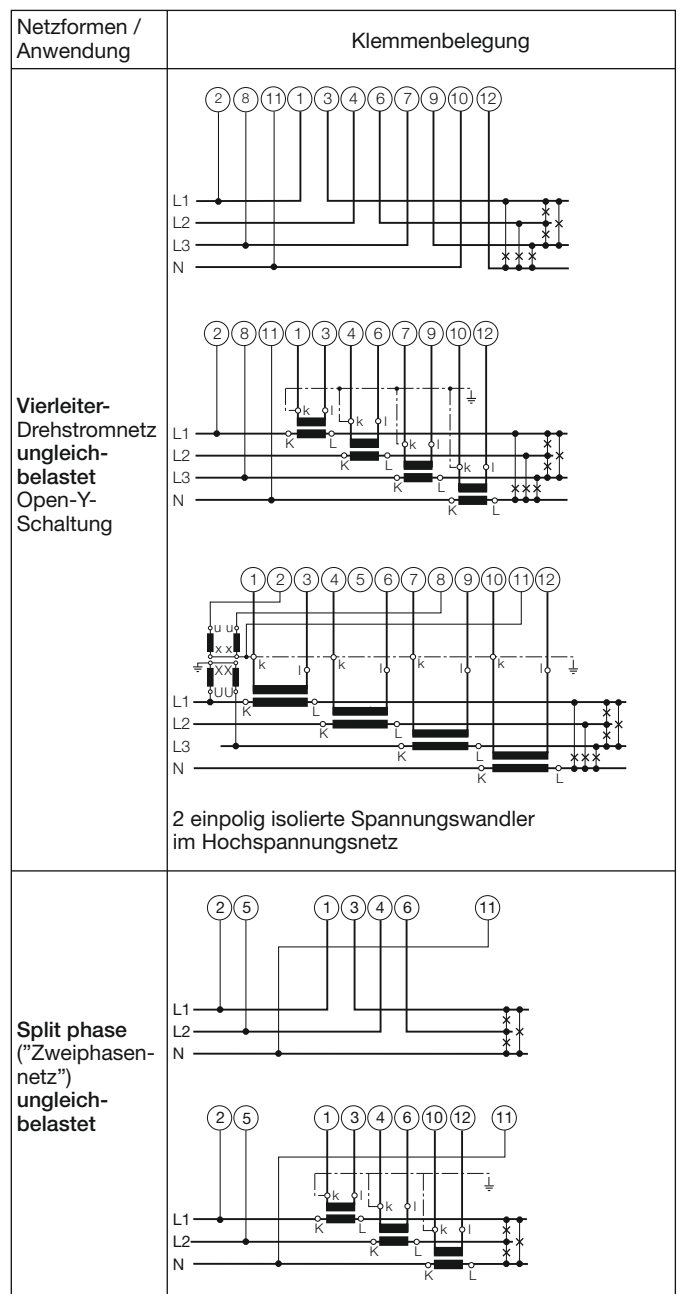
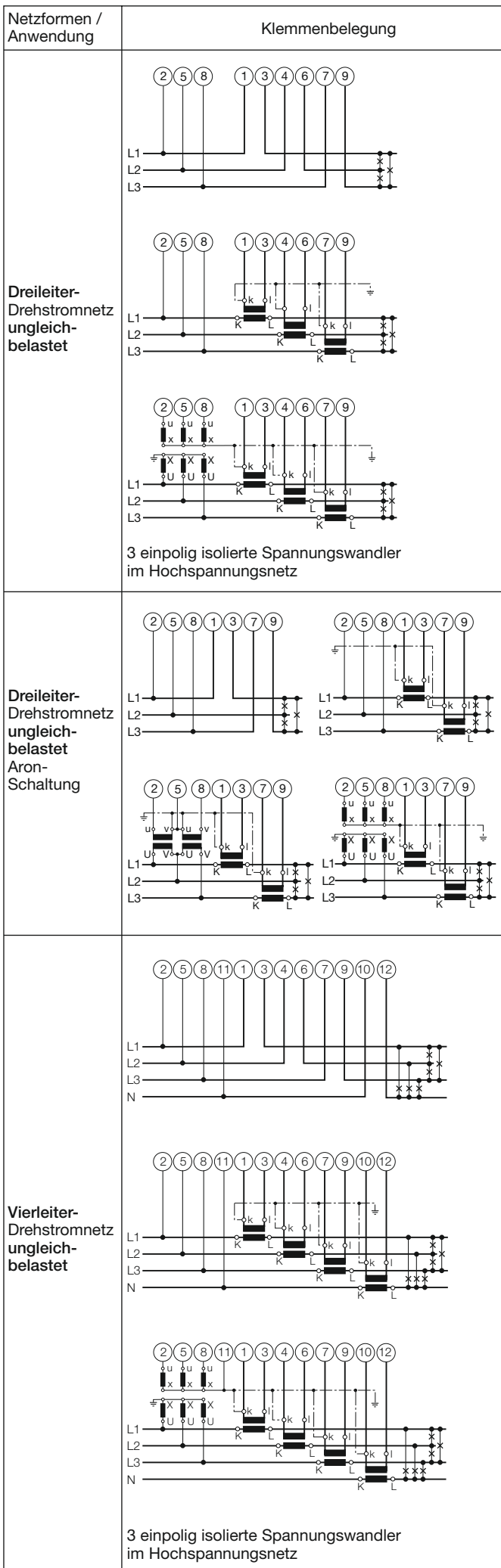

Mass-Skizze

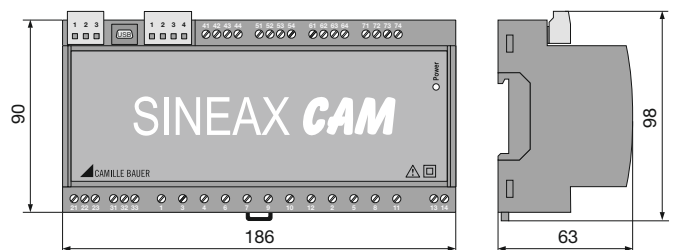

SINEAX CAM im Tragschienegehäuse auf Hutschiene (35 x 15 mm oder 35 x 7,5 mm) aufgeschnappt. Anschluss-Klemmen teilweise steckbar.

Obligatory safety instructions are marked with the following symbols in these directions:

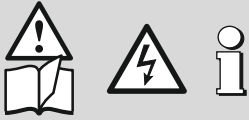

Device may only be disposed of in a professional manner!

Safety Instructions



Camille Bauer Metrawatt Ltd.
Aargauerstrasse 7
CH-5610 Wohlen/Switzerland
Phone +41 56 618 21 11
Fax +41 56 618 21 21
info@cbmag.com
www.camillebauer.com

Universal heavy current measuring unit SINEAX CAM



156 449-04

09.14

Read first, then ...



Perfect and safe operation requires that these Safety Instructions as well as the Operating Instructions (Nr. 156 481) have been **read** and understood!

This device should only be handled by staff members who are familiar with it and authorised to work on electric facilities.

Tampering with the device voids any warranty!

Scope of supply

SINEAX CAM
1 Safety Instructions
1 Software and documentation CD
1 USB cable

Brief description

The configurable SINEAX CAM measuring unit is designed for AC power distribution systems or industrial facilities. The reliable device determines the current network condition and the degree of impurity caused by non-linear consumers through a comprehensive harmonics analysis.

The device is also suited to the acquisition of special input signals with variable sampling intervals (e.g. full wave controls), altered sine shapes (e.g. phase-angle controls) or strong distortions.

Technical data

Measuring input →

Voltage:	57...400V (L-N), or 100...693V (L-L)
Current:	1...5 A
Rated frequency:	50/60 Hz
Connection mode:	One-phase, 3 or 4 wire systems of a balanced or asymmetrical load, split phase. 4-quadrant operation

Power supply →

Option 1:	100...230 V AC/DC ± 15%
Option 2:	24...60 V DC ± 15%
Input power:	≤ 4...20 VA (depending on I/O interface)
Green LED:	Power On indication

Interfaces ↔

Bus connection:	RS-485 (Modbus protocol), via plug terminals, max. length 1200 m (4000 ft)
USB connection:	USB 2.0, 5-pin Mini-B

Relay →

Load capacity:	250 V AC, 2 A, 500 VA or 30 V DC, 2 A, 60 W
----------------	---

I/O interface

Different groups of terminals with defined input/output functions are available depending on the version. These groups are galvanically isolated from each other.

Analog outputs →

2x 0/4...20 mA per group of terminals, galvanically connected or
2x ± 20 mA per group of terminals, galvanically connected
Burden voltage 10 V max.
Burden 0...500 Ω (max. 20 mA)

Analog inputs →

2x 0/4...20 mA per group of terminals, galvanically connected
Input resistance < 40 Ω

Digital inputs/outputs →

3 per group of terminals, in relation to software configurable as passive inputs or outputs (all the same), according to EN 61131-2
Inputs 24 V DC (Type 3)
Outputs 24 V DC, rated current 50 mA (60 mA max.)

Digital inputs 125 V DC →

3 per group of terminals
Inputs 48 / 125 V DC

HV input 110 V / 230 V AC →

Voltage range: 0...265 V AC (1.1 x 240 V)
Frequency: 50...60 Hz
Switching limit: 40...80 V AC
Input impedance: 20 ... 30 kΩ

Mounting

The device is mounted on a top-hat rail.



Please ensure that the operating temperature **limits are not exceeded** when determining the place of mounting (place of measurement):
- 10 ... 55 °C

Snap housing on the top-hat rail (EN 50 022) (see Figure 1).

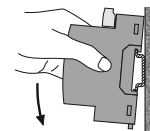

Figure 1. Mounting on top-hat rail 35 x 15 or 35 x 7.5 mm.

Disassembly

Remove the housing from the mounting rail according to Figure 2.

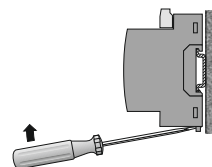

Figure 2

Electric connections

Screw connections are used. They are designed for cross sections of 4 mm² for single wire leads and 2 x 2.5 mm² for multiwire leads.



Ensure under all circumstances that the leads are free of potential when connecting them!



Please observe, ...
... that the data on the type plate must be adhered to!

Analog outputs

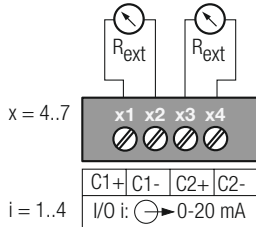

Analog inputs

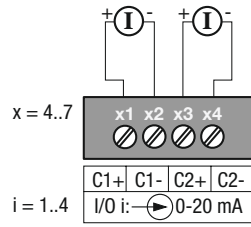

Digital outputs

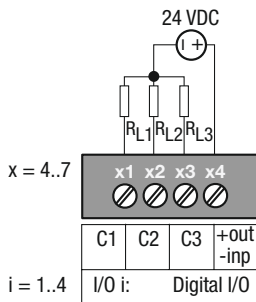

Digital inputs

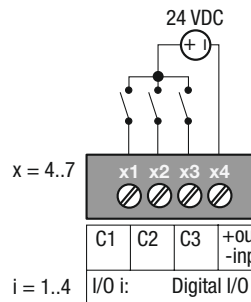

HV input 110/230 VAC

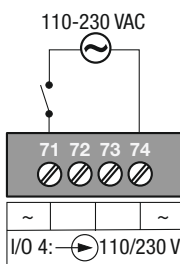

Digital inputs 125 V DC

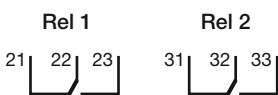
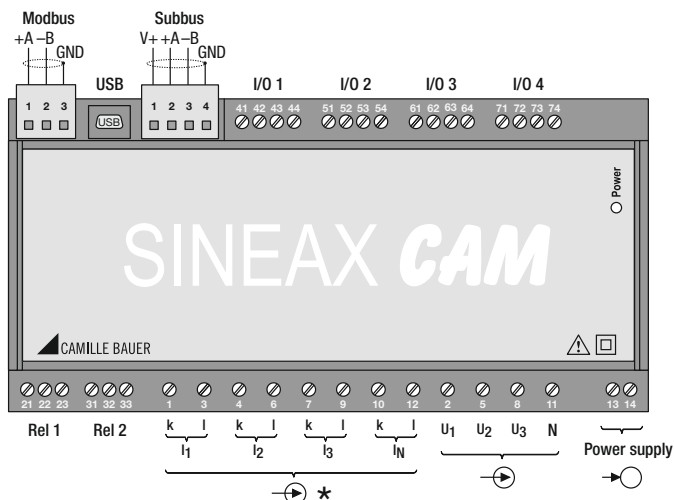
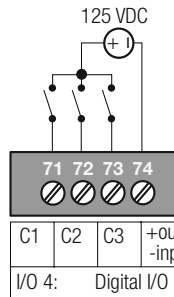

When the device is switched off, the status of the relay contact is not defined. Dangerous voltages may occur.

* Current inputs for Rogowski coils:
See operating instructions on CD

Types of connections

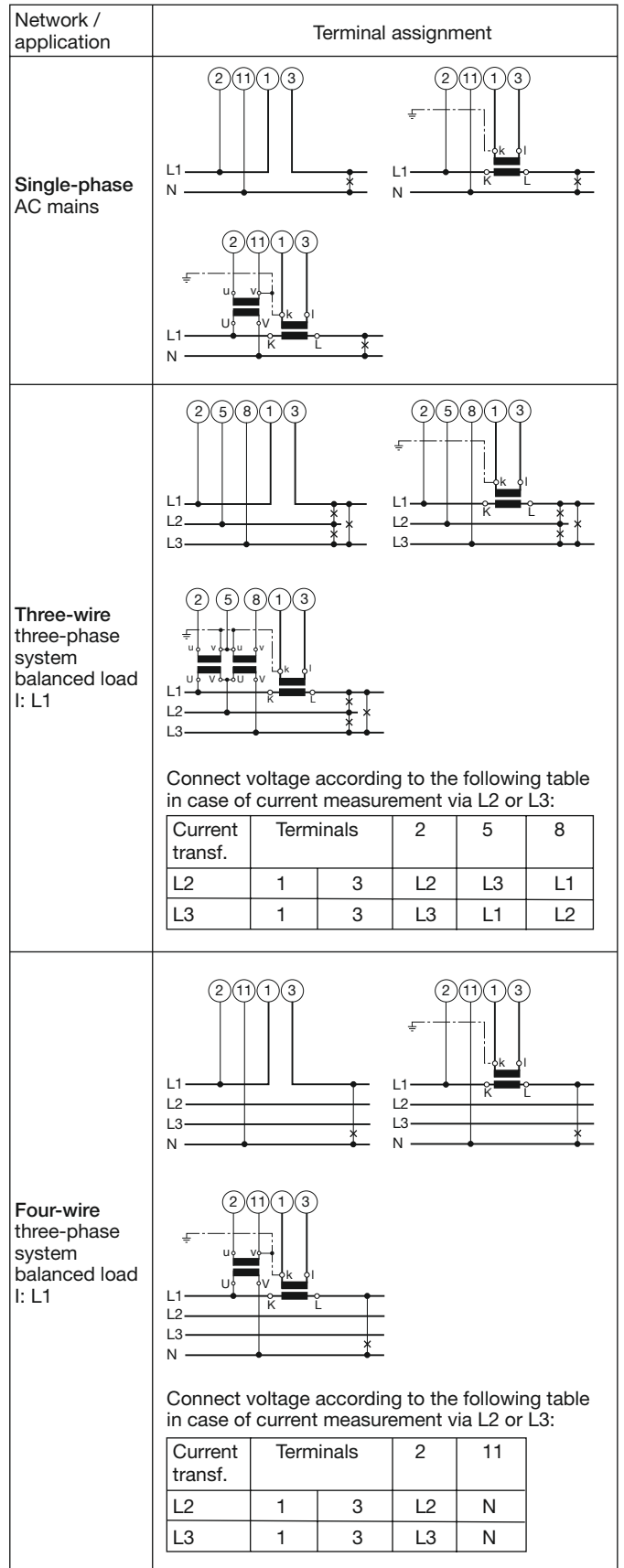

A marked and easily accessible switch for turning off the power supply has to be arranged in the vicinity of the device.

In case of a supply of direct current > 125 V DC, an external fuse has to be provided in the power supply circuit.

Otherwise, the national provisions (e.g. in Germany VDE 0100 "Conditions concerning the erection of heavy current facilities with rated voltages below 1000 V") have to be observed in the installation and material selection of electric lines!

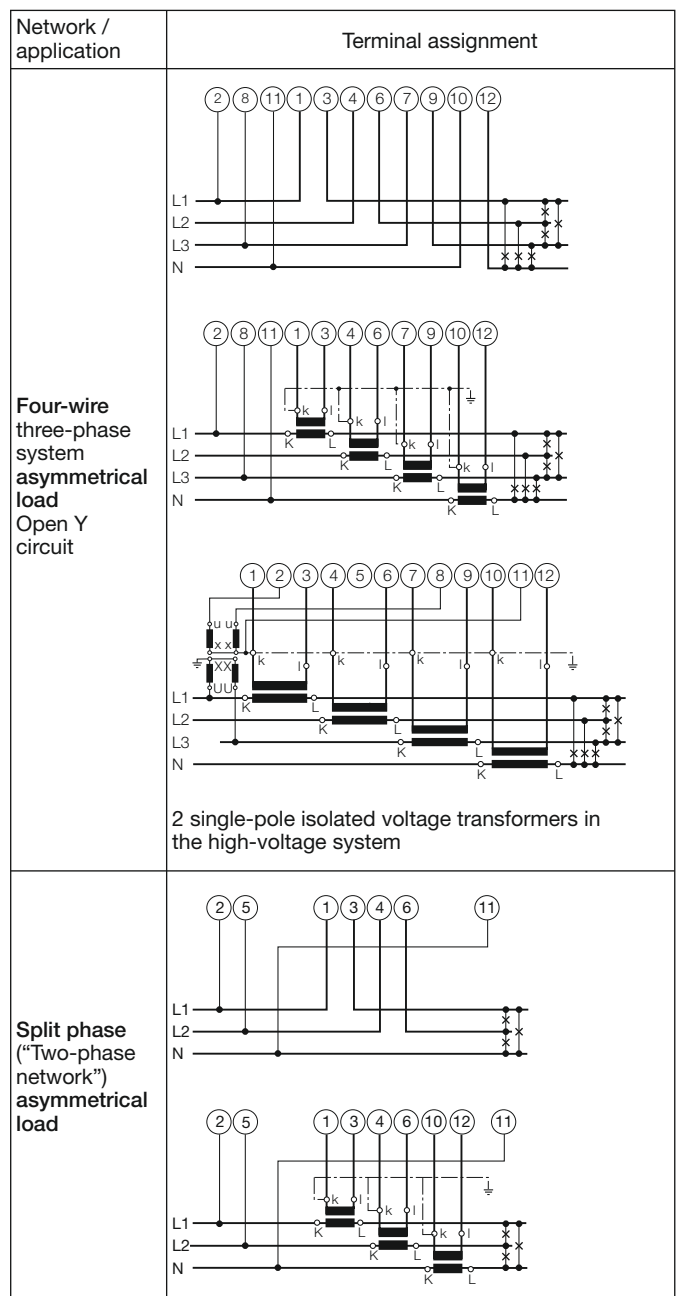
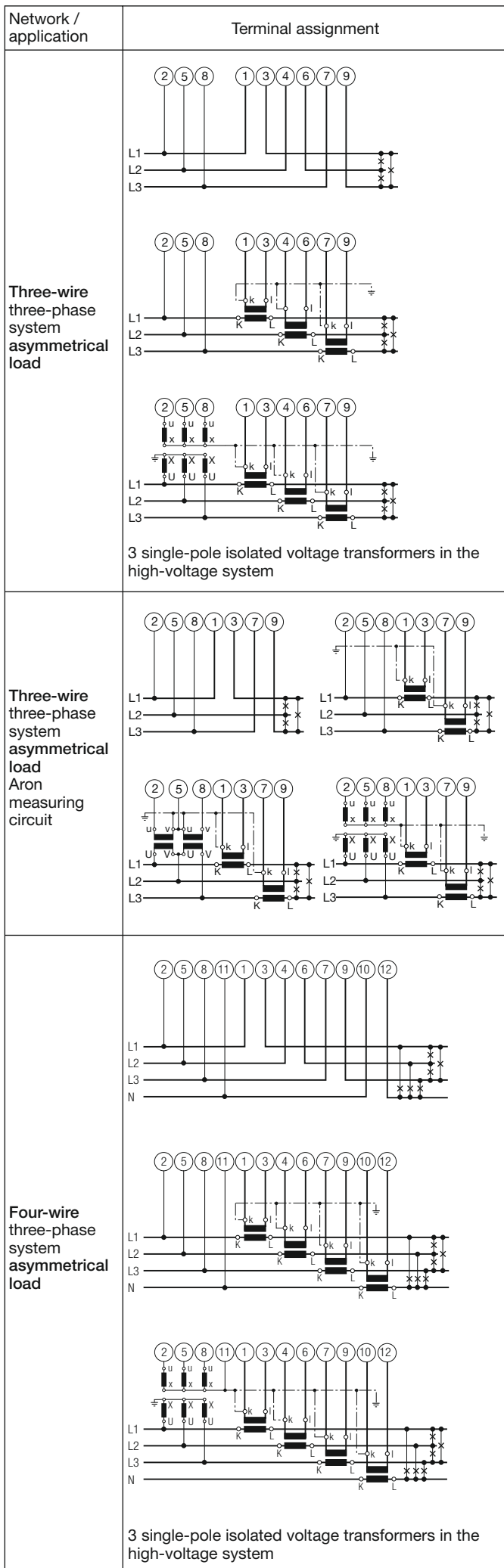

Dimensional sketch

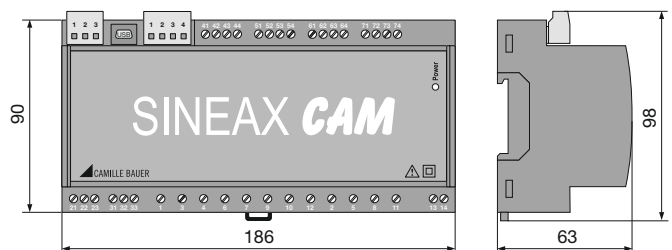

SINEAX CAM in mounting rail housing snapped on top-hat rail (35 x 15 mm or 35 x 7.5 mm). Terminals partly pluggable.

Les instructions de sécurité obligatoires sont référées par les symboles suivants:



Cet appareil doit être éliminé d'une manière professionnelle!

Instructions relatives à la sécurité

Dispositif de mesure courant forts universel SINEAX CAM



Camille Bauer Metrawatt SA
Aargauerstrasse 7
CH-5610 Wohlen/Suisse
Téléphone +41 56 618 21 11
Téléfax +41 56 618 21 21
info@cbmag.com
www.camillebauer.com



156 449-04

09.14

A lire en priorité, puis ...



Le fonctionnement correct et sans risques de l'appareil suppose que l'on ait lu et compris le présente notice de sécurité, ainsi que le mode d'emploi («Operating Instructions» Nr. 156 481 ou «Betriebsanleitung» Nr. 156 457)!

Cet appareil ne devrait être manipulé que par des membres du personnel familiers avec et autorisés à intervenir sur des installations électriques.

Toute intervention maladroite dans l'appareil annule la garantie!

Etendue de la fourniture

SINEAX CAM
1 Instructions de sécurité
1 CD avec logiciel et documentation
1 Câble USB

Brève description

L'unité de mesure configurable SINEAX CAM a été conçue pour les systèmes de distribution de puissance ou les installations industrielles. Cette appareil de haute fiabilité détermine l'état du réseau et le niveau d'impuretés causé par les charges non linéaires à l'aide d'une analyse d'harmoniques comprehensive.

L'appareil est aussi adapté à l'acquisition de signaux d'entrée spéciaux, avec des intervalles d'échantillonnage variables (p.ex. train d'ondes sinusoïdales déformées (p.ex. régulation par angle de phase) ou fortes distorsions.

Caractéristiques techniques

Entrées mesures

Tension:	57...400V (L-N), ou 100...693V (L-L)
Courant:	1...5 A
Fréquence:	50/60 Hz
Mode de connexion:	Monophasé, réseau 3 ou 4 fils à charges équilibrées ou déséquilibrées, fonctionnement 4 quadrants

Alimentation auxiliaire

Option 1:	100...230 V AC/DC ± 15%
Option 2:	24...60 V DC ± 15%
Consommation:	≤ 4...20 VA (selon interface I/O)
LED verte:	Power-On indication

Interfaces

Connection Bus:	RS-485 (Modbus protocol), via bornes enfichables, distance max. 1200 m (4000 ft)
Connexion:	USB 2.0, 5-pôle Mini-B

Relais

Pouvoir de coupure:	250 V AC, 2 A, 500 VA ou 30 V DC, 2 A, 60 W
---------------------	---

Interface I/O

Différents groupes de bornes avec des fonctions entrée/sortie définies sont disponibles selon la version. Ces groupes sont isolé galvaniquement les uns des autres.

Sorties analogiques

2x 0/4...20 mA par groupe de bornes, non isolées galvaniquement ou 2x ± 20 mA par groupe de bornes, non isolées galvaniquement
Tension de charge 10 V max.
Charge 0...500 Ω (max. 20 mA)

Entrées analogiques

2x 0/4...20 mA par groupe de bornes, non isolées galvaniquement
Résistance d'entrée < 40 Ω

Entrées/sorties TOR

3 par groupe de bornes, configurables par software comme entrées passives ou sorties (toutes de la même manière), selon EN 61131-2
Entrées 24 V DC (type 3)
Sorties 24 V DC, courant nominal 50 mA (60 mA max.)

Entrées TOR 125 V DC

3 par groupe de bornes
Entrées 48 / 125 V DC

Entrées HV 110 V / 230 V AC

Plage de tension:	0...265 V AC (1,1 x 240 V)
Fréquence:	50...60 Hz
Limite de coupure:	40...80 V AC
Impédance d'entrée:	20 ... 30 kΩ

Montage

L'appareil se monte sur rail DIN.



Pour la détermination du lieu de montage vérifier que les limites de température ne sont pas dépassées:
- 10 ... 55 °C

Boîtier encliquetable sur rail (EN 50 022) (voir fig. 1).

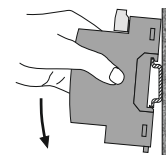

Fig. 1. Montage sur rail DIN 35 x 15 ou 35 x 7,5 mm.

Démontage

Enlever le boîtier du rail de montage selon Fig. 2.

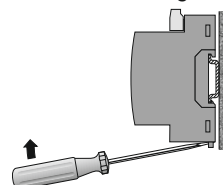

Fig. 2

Raccordements électriques

Bornes à vis pour fil rigide jusqu'à 4 mm² ou 2 x 2,5 mm² pour fils souples.



S'assurer que les conducteurs sont libres de potentiel en toutes circonstances avant de les connecter!



Vérifier, ...

... la concordance avec les données figurant sur la plaque signalétique!

Sorties analogiques

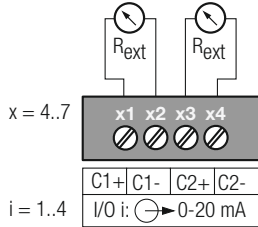

Entrées analogiques

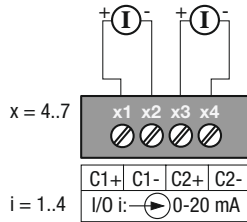

Sorties TOR

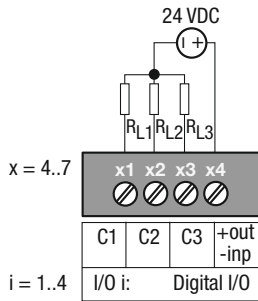

Entrées TOR

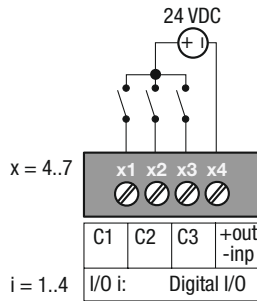

Entrées HV 110/230 VAC

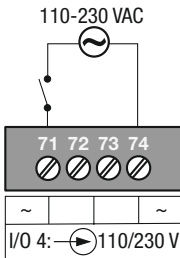

Entrées TOR 125 V DC

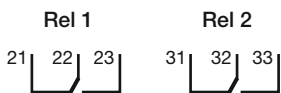
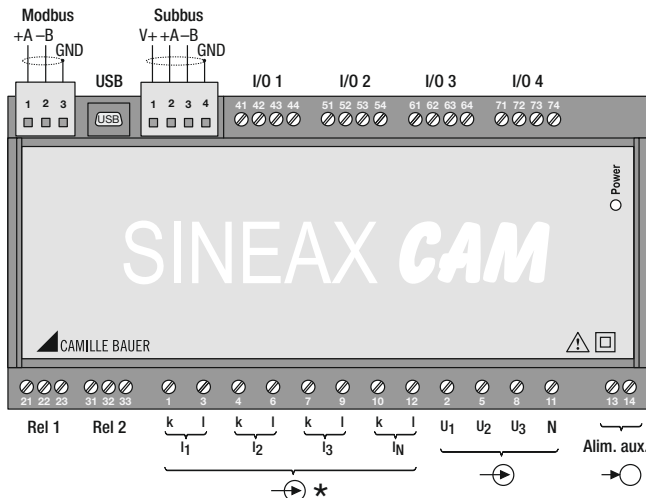
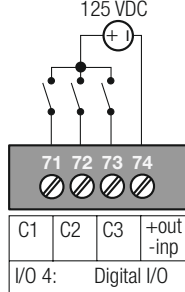

Si l'appareil est hors tension, l'état du contact du relais n'est pas défini. Des tensions dangereuses peuvent apparaître.

* Entrées courants pour des enroulements de Rogowski: Voir instructions de fonctionnement sur CD

Raccordement

Réseau / application	Affectation des bornes															
Réseau alternatif monophasé																
Réseau triphasé 3 fils à charges équilibrées I: L1	<p>Brancher les tensions selon le tableau suivant dans le cas de mesure de courant via L2 ou L3:</p> <table border="1"> <thead> <tr> <th>Transfo de courant</th> <th>Bornes</th> <th>2</th> <th>5</th> <th>8</th> </tr> </thead> <tbody> <tr> <td>L2</td> <td>1</td> <td>3</td> <td>L2</td> <td>L3</td> </tr> <tr> <td>L3</td> <td>1</td> <td>3</td> <td>L3</td> <td>L1</td> </tr> </tbody> </table>	Transfo de courant	Bornes	2	5	8	L2	1	3	L2	L3	L3	1	3	L3	L1
Transfo de courant	Bornes	2	5	8												
L2	1	3	L2	L3												
L3	1	3	L3	L1												
Réseau triphasé 4 fils à charges équilibrées I: L1	<p>Brancher les tensions selon le tableau suivant dans le cas de mesure de courant via L2 ou L3:</p> <table border="1"> <thead> <tr> <th>Transfo de courant</th> <th>Bornes</th> <th>2</th> <th>11</th> </tr> </thead> <tbody> <tr> <td>L2</td> <td>1</td> <td>3</td> <td>L2</td> </tr> <tr> <td>L3</td> <td>1</td> <td>3</td> <td>L3</td> </tr> </tbody> </table>	Transfo de courant	Bornes	2	11	L2	1	3	L2	L3	1	3	L3			
Transfo de courant	Bornes	2	11													
L2	1	3	L2													
L3	1	3	L3													



Un interrupteur, reperé et facile d'accès, courant l'alimentation auxiliaire doit être installé à proximité de l'appareil.

Dans le cas d'alimentation > 125 V DC, un fusible extérieur doit être monté.

D'autre part, la réglementation nationale (p.ex. en Allemagne VDE 0100 «Conditions concernant la réalisation d'installations à courants forts sous tension nominale inférieure à 1000 V») doit être observée dans l'installation et le choix du matériel des lignes électriques!

Réseau / Application	Affectation des bornes
Réseau triphasé 3 fils à charges asymétriques	<p>3 transformateurs de potentiel indépendants dans le circuit HT</p>
Réseau triphasé 3 fils à charges asymétriques, montage ARON	
Réseau triphasé 4 fils à charges asymétriques	<p>3 transformateurs de potentiel indépendants dans le circuit HT</p>

Réseau / Application	Affectation des bornes
Réseau triphasé 4 fils à charges non équilibrées, circuit Y ouvert	<p>2 transformateurs de potentiel indépendants dans le circuit HT</p>
Phase portée ("Réseau biphasé") charge asymétrique	

Dimensions

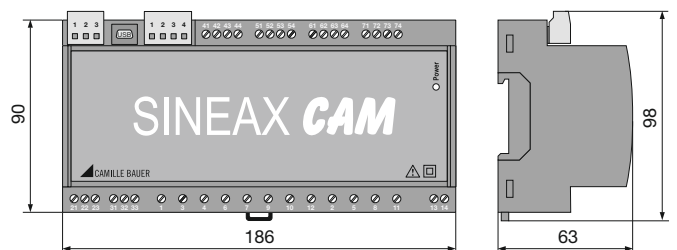

SINEAX CAM en boîtier montable sur rail DIN (35 x 15 mm ou 35 x 7,5 mm). Bornes enchassées en partie.

In questo manuale, le indicazioni per la sicurezza che devono essere rigorosamente osservate, sono contrassegnate con questi simboli:



Gli strumenti possono essere rottamati solamente secondo le normative!

Indicazioni per la sicurezza



Camille Bauer Metrawatt AG
Aargauerstrasse 7
CH-5610 Wohlen/Svizzera
Telefono +41 56 618 21 11
Telefax +41 56 618 21 21
info@cbmag.com
www.camillebauer.com

Convertitore universale per grandezze elettriche SINEAX CAM



156 449-04

09.14

Prima leggere, poi ...



La lettura e la comprensione delle presenti istruzioni di sicurezza e del libretto d'uso («Operating Instructions» No. 156 481 o «Betriebsanleitung» Nr. 156 457) costituiscono il presupposto per un funzionamento corretto e sicuro dell'apparecchio!

Questi apparecchi devono essere installati unicamente da personale qualificato ed autorizzato a lavorare sugli impianti elettrici.

In caso di apertura della custodia dello strumento la garanzia decade automaticamente!

Fornitura

SINEAX CAM
1 Indicazioni di sicurezza
1 CD con software e documentazione
1 Cavo USB

Breve descrizione

Il convertitore programmabile SINEAX CAM è destinato alla misura di reti elettriche di distribuzione e/o di impianti industriali in corrente alternata. E' possibile rilevare con affidabilità lo stato attuale della rete e, grazie ad una ampia analisi delle armoniche, il suo grado di impurità causato dai carichi non lineari.

Lo strumento è adatto anche per l'acquisizione di segnali speciali a periodicità variabile (regolatori ad onda piena), sinusoidali ad onda parzializzata (regolatori a controllo di fase) o con forti distorsioni.

Dati tecnici

Ingresso di misura

Tensione: 57...400V (L-N), o 100...693V (L-L)
Corrente: 1...5 A
Frequenza nominale: 50/60 Hz
Tipo di collegamento: Monofase, trifase 3 o 4 fili carico equilibrato o squilibrato, fasi separate. Funzionamento 4 quadranti

Alimentazione ausiliaria

Opzione 1: 100...230 V AC/DC \pm 15%
Opzione 2: 24...60 V DC \pm 15%
Potenza assorbita: \leq 4...20 VA (secondo interfaccia I/O)
LED verde: Acceso, strumento alimentato

Interfaccia

Collegamento Bus: RS-485 (Protocollo Modbus), mediante morsetti ad innesto, lunghezza massima bus 1200 m (4000 ft)

Collegamento USB: USB 2.0, 5 poli Mini-B

Relè

Sovraccaricabilità: 250 V AC, 2 A, 500 VA oppure 30 V DC, 2 A, 60 W

Interfaccia I/O

In funzione dell'esecuzione dello strumento sono a disposizione diversi gruppi di morsetti con caratteristiche d'Ingresso/Uscita specifiche. Questi gruppi sono separati galvanicamente tra di loro.

Uscite analogiche

2x 0/4...20 mA per gruppo di morsetti, galvanicamente collegati o
2x \pm 20 mA per gruppo di morsetti, galvanicamente collegati
Tensione di carico max 10 V
Carico 0...500 Ω (max 20 mA)

Ingressi analogiche

2x 0/4...20 mA per gruppi di morsetti, galvanicamente collegati
Resistenza di ingresso < 40 Ω

Ingressi / Uscite digitali

3 per gruppo di morsetti, configurabili via software come ingressi o uscite passive (stessa modalità per tutti), secondo EN 61131-2
Ingressi 24 V DC (tipo 3)
Uscite 24 V DC, corrente nominale 50 mA (60 mA max)

Ingressi digitali 125 V DC

3 per gruppo di morsetti
Ingressi 48 / 125 V DC

Ingresso HV 110 V / 230 V AC

Campo di tensione: 0...265 V AC (1,1 x 240 V)
Frequenza: 50...60 Hz
Soglia di commutazione: 40...80 V AC
Impedenza di ingresso: 20 ... 30 k Ω

Fissaggio

Il fissaggio dello strumento avviene su guida DIN.



Per la determinazione del luogo di montaggio (luogo di misura) si deve prestare attenzione che non vengano superati i limiti della temperatura di esercizio:
- 10 ... 55 °C

Agganciare la custodia sulla guida (EN 50 022), vedere figura 1.



Figura 1. Fissaggio su guida 35 x 15 oppure 35 x 7,5 mm.

Rimozione

Staccare la custodia dalla guida portante come da figura 2.

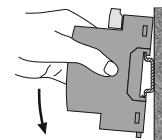

Figura 2

Conessioni elettriche

I collegamenti sono eseguiti tramite morsetti a vite. Essi sono adatti per conduttori a filo unico con 4 mm² di sezione o per conduttori a più fili con sezione 2 x 2,5 mm².

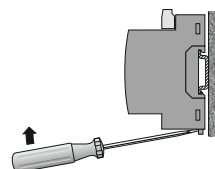

Assicurarsi che l'apparecchio non sia in tensione quando si effettuano i collegamenti elettrici!



Ed inoltre si deve rispettare ...
... che siano rispettati i dati riportati sulla targhetta identificativa!

Uscite analogiche

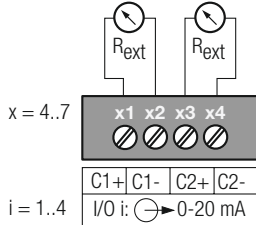

Ingressi analogiche

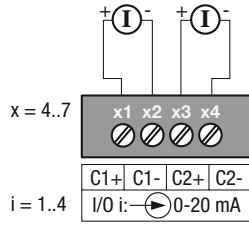

Uscite digitali

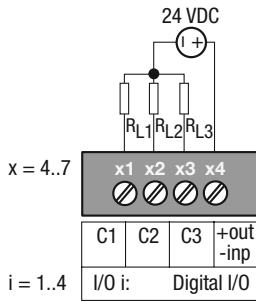

Ingressi digitali

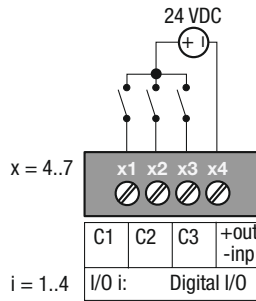

Ingresso HV 110/230 VAC

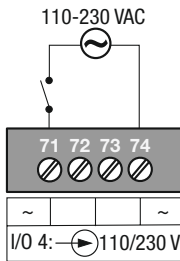

Ingressi digitali 125 V DC

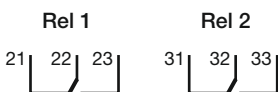
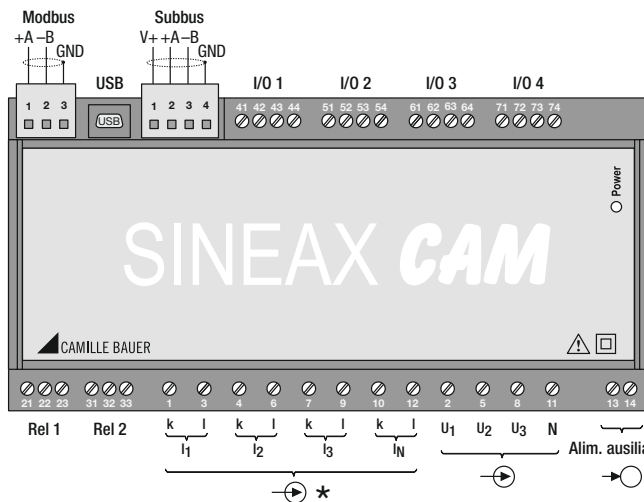
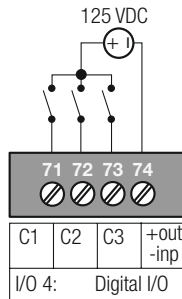

A strumento non alimentato lo del relè non è definito. Tensione pericolose potrebbero essere presenti.

* Ingressi di corrente per bobine di Rogowski:
Vedere istruzioni per l'uso su CD

Collegamenti

Sistema / Applicazione	Terminali														
Monofase AC															
Trifase a tre fili equilibrato I: L1															
	<p>Con la misura della corrente tramite L2 o L3, eseguire il collegamento della tensione secondo la seguente tabella:</p> <table border="1"> <thead> <tr> <th>Trasf. fase</th> <th>Morsetti</th> <th>2</th> <th>5</th> <th>8</th> </tr> </thead> <tbody> <tr> <td>L2</td> <td>1</td> <td>3</td> <td>L2</td> <td>L3</td> </tr> <tr> <td>L3</td> <td>1</td> <td>3</td> <td>L3</td> <td>L1</td> </tr> </tbody> </table>	Trasf. fase	Morsetti	2	5	8	L2	1	3	L2	L3	L3	1	3	L3
Trasf. fase	Morsetti	2	5	8											
L2	1	3	L2	L3											
L3	1	3	L3	L1											
Trifase a quattro fili carico equilibrato I: L1															
	<p>Con la misura della corrente tramite L2 o L3, eseguire il collegamento della tensione secondo la seguente tabella:</p> <table border="1"> <thead> <tr> <th>Trasf. fase</th> <th>Morsetti</th> <th>2</th> <th>11</th> </tr> </thead> <tbody> <tr> <td>L2</td> <td>1</td> <td>3</td> <td>L2</td> </tr> <tr> <td>L3</td> <td>1</td> <td>3</td> <td>L3</td> </tr> </tbody> </table>	Trasf. fase	Morsetti	2	11	L2	1	3	L2	L3	1	3	L3		
Trasf. fase	Morsetti	2	11												
L2	1	3	L2												
L3	1	3	L3												



Per il distacco dell'alimentazione si deve prevedere nelle vicinanze dello strumento un interruttore facilmente individuabile e raggiungibile.

In caso di alimentazione continua > 125 V DC si deve prevedere nel circuito dell'alimentazione un fusibile esterno.

Inoltre devono essere rispettate tutte le prescrizioni nazionali (es. per la Germania le VDE 0100 «Condizioni per il montaggio di impianti elettrici con tensioni nominali inferiori a 1000 V») per l'installazione e la posa di cavi ed apparecchiature elettriche!

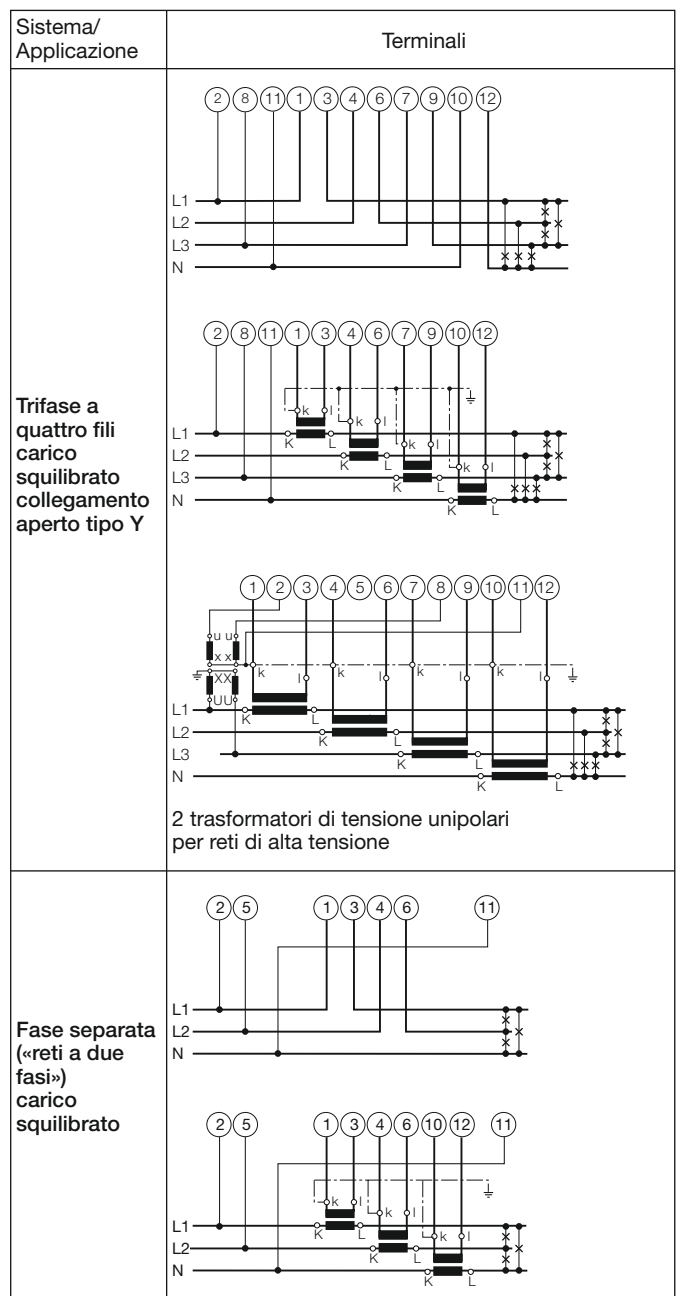
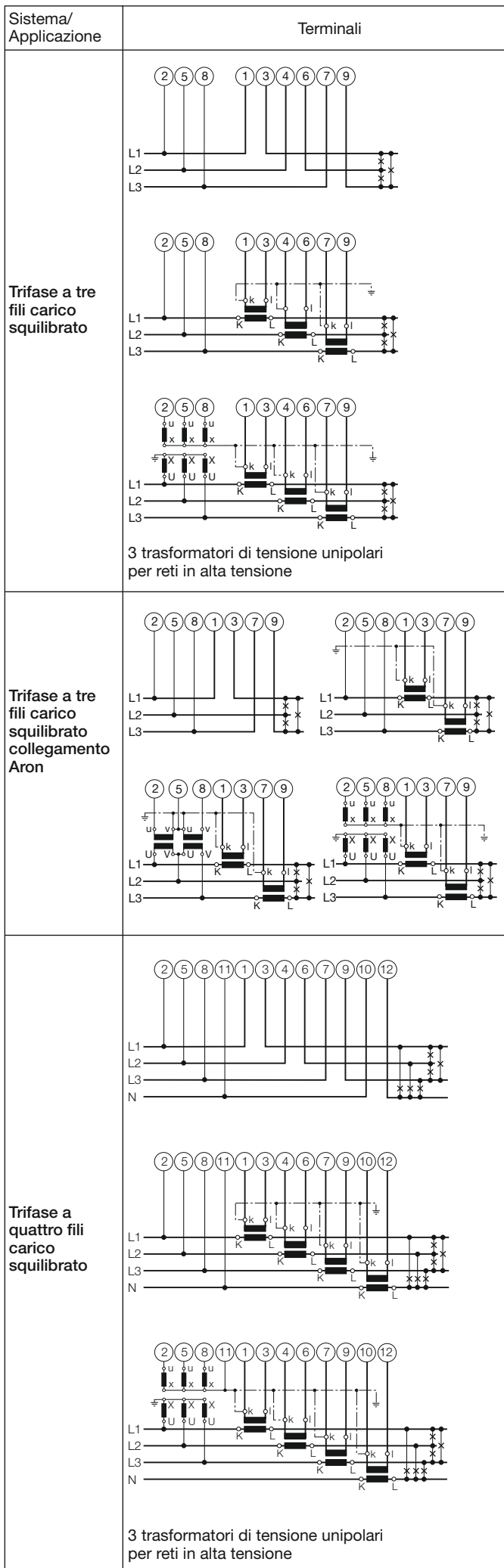

Dimensioni

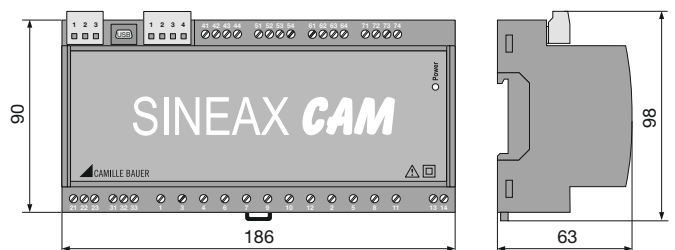

SINEAX CAM in custodia per montaggio su guida (35 x 15 mm oppure 35 x 7,5 mm). Morsetti di collegamento parzialmente estraibili.

Las instrucciones de seguridad obligatorias están marcadas con los siguientes símbolos en estas direcciones:



El aparato sólo puede desecharse de manera profesional!

Instrucciones de seguridad

Unidad de medida universal para corrientes fuertes SINEAX CAM



Camille Bauer Metrawatt AG
Aargauerstrasse 7
CH-5610 Wohlen/Suiza
Teléfono +41 56 618 21 11
Telefax +41 56 618 21 21
correo electrónico:
info@cbmag.com
www.camillebauer.com



156 449-04

09.14

Leer primero, entonces ...



El funcionamiento óptimo y seguro tiene como premisa la lectura y comprensión de estas indicaciones de seguridad y del manual de instrucciones («Operating Instructions» No. 156 481 o «Betriebsanleitung» Nr. 156 457)!

Este aparato debe ser manejado únicamente por personal familiarizado con él y autorizado para trabajar en instalaciones eléctricas.

La manipulación indebida del aparato elimina la garantía!

Alcance de suministro

SINEAX CAM
1 Instrucciones de seguridad
1 Software y documentación CD
1 Cable USB

Breve descripción

La unidad de medida configurable SINEAX CAM está diseñada para sistemas de distribución de corriente alterna o instalaciones industriales. Este fiable dispositivo determina la situación de la red y el grado de pérdida de calidad, debido a consumos no lineales, mediante un análisis comprensible de armónicos.

El aparato también es apropiado para la adquisición de señales especiales de entrada con intervalo de muestreo variable (por ejemplo, controles de onda completa), formas de onda alteradas (por ejemplo, controles fase-ángulo) o fuertes distorsiones.

Datos técnicos

Entrada de medida →

Tensión: 57...400V (L-N), o 100...693V (L-L)
Corriente: 1...5 A
Frecuencia: 50/60 Hz
Conexión: Monofásico, sistemas 3 o 4 hilos para cargas equilibradas o desequilibradas, operación en cuatro cuadrantes

Alimentación auxiliar →

Opción 1: 100...230 V AC/DC ± 15%
Opción 2: 24...60 V DC ± 15%
Consumo: ≤ 4...20 VA (dependiendo del interface entrada/salida)
LED verde: Indicación de encendido

Interfaces ↔

Conexión bus: RS-485 (protocolo Modbus), mediante terminales enchufables, longitud máxima 1200 m (4000 pies)
Conexión USB: USB 2.0, 5-pines Mini-B

Relé →

Capacidad de carga: 250 V AC, 2 A, 500 VA o 30 V DC, 2 A, 60 W

Interface Entrada/Salida

Diferentes grupos de terminales con funciones definidas de entrada/salida se encuentran disponibles según la versión. Estos grupos están galvánicamente aislados unos de otros.

Salidas analógicas →

2x 0/4...20 mA por grupo de terminales, galvánicamente conectados o 2x ± 20 mA por grupo de terminales, galvánicamente conectados
Tensión de carga 10 V max.
Carga 0...500 Ω (máx. 20 mA)

Entradas analógicas →

2x 0/4...20 mA por grupo de terminales, galvánicamente conectados
Resistencia de entrada < 40 Ω

Entradas/salidas digitales →

3 por grupo de terminales, configurables por software como entradas pasivas o salidas (todas igual), de acuerdo a EN 61131-2
Entradas 24 V DC (Tipo 3)
Salidas 24 V DC, para 50 mA (60 mA máx.)

Entradas digitales 125 V DC →

3 por grupo de terminales
Entradas 48 / 125 V DC

Entrada alta tensión 110 V / 230 V AC →

Alcance de tensión: 0...265 V AC (1,1 x 240 V)
Frecuencia: 50...60 Hz
Límite de conmutación: 40...80 V AC
Impedancia de entrada: 20 ... 30 kΩ

Montaje

El aparato se monta en carril tipo "T".



Por favor, asegurar que la temperatura se encuentre dentro de los límites de operación cuando se determine el lugar de montaje:
- 10 ... 55 °C

Montaje rápido en carril "T" (EN 50 022) (ver Figura 1).



Figura 1. Montaje en carril "T" 35 x 15 o 35 x 7,5 mm.

Desmontaje

Quitar la caja del carril como muestra la Figura 2.

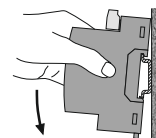

Figura 2

Conexiones eléctricas

Se usan conexiones atornilladas. Son diseñadas para secciones de 4 mm² para conductores de un solo hilo y 2 x 2,5 mm² para conductores multihilo.

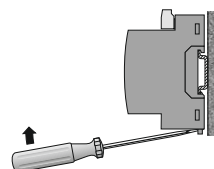

Asegurarse bajo todas circunstancias que los conductores se encuentran libres de potencial cuando se conectan!



Por favor, observar, ...
... que los datos se encuentren indicados en la placa!

Salidas analógicas

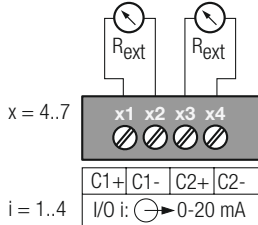

Entradas analógicas

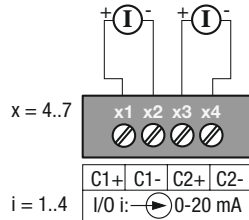

Salidas digitales

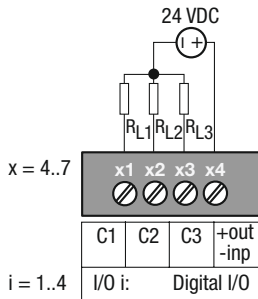

Entradas digitales

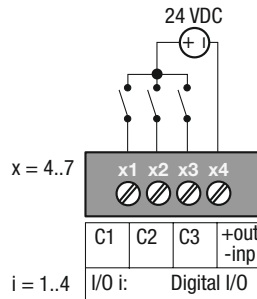

Entrada alta tensión 110/230 VAC

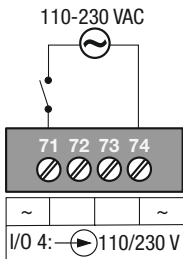

Entradas digitales 125 V DC

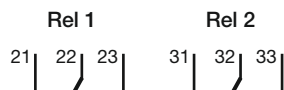
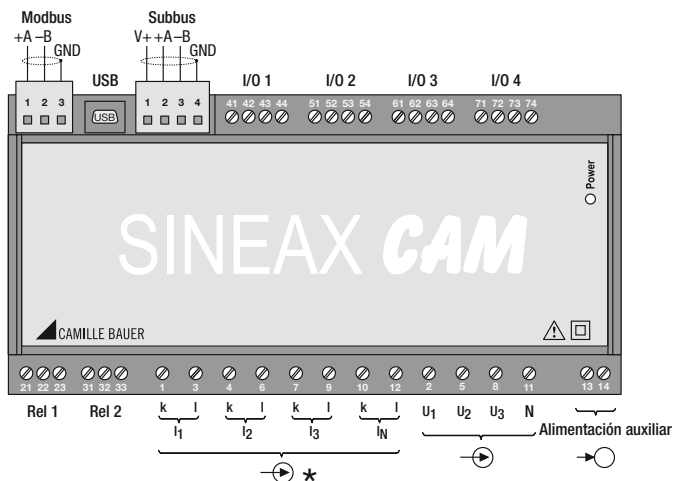
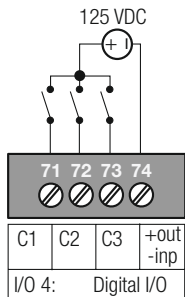

Cuando se apaga el aparato, el estado de los contactos del relé no están definidos. Pueden generarse tensiones peligrosas.

* Entradas de corriente para bobinas Rogowski:
Ver manual de instrucciones en CD

Tipos de conexión

Red / Aplicación	Asignación de terminales																
Monofásico Red AC																	
Tres hilos Sistema trifásico equilibrado I: L1																	
	<p>Conectar la tensión de acuerdo con la siguiente tabla en caso de medida de corriente mediante L2 o L3:</p> <table border="1"> <thead> <tr> <th>Transf. corriente</th> <th>Terminales</th> <th>2</th> <th>5</th> <th>8</th> </tr> </thead> <tbody> <tr> <td>L2</td> <td>1</td> <td>3</td> <td>L2</td> <td>L3</td> <td>L1</td> </tr> <tr> <td>L3</td> <td>1</td> <td>3</td> <td>L3</td> <td>L1</td> <td>L2</td> </tr> </tbody> </table>	Transf. corriente	Terminales	2	5	8	L2	1	3	L2	L3	L1	L3	1	3	L3	L1
Transf. corriente	Terminales	2	5	8													
L2	1	3	L2	L3	L1												
L3	1	3	L3	L1	L2												
Cuatro hilos Sistema trifásico equilibrado I: L1																	
	<p>Conectar la tensión de acuerdo con la siguiente tabla en caso de medida de corriente mediante L2 o L3:</p> <table border="1"> <thead> <tr> <th>Transf. corriente</th> <th>Terminales</th> <th>2</th> <th>11</th> </tr> </thead> <tbody> <tr> <td>L2</td> <td>1</td> <td>3</td> <td>L2</td> <td>N</td> </tr> <tr> <td>L3</td> <td>1</td> <td>3</td> <td>L3</td> <td>N</td> </tr> </tbody> </table>	Transf. corriente	Terminales	2	11	L2	1	3	L2	N	L3	1	3	L3	N		
Transf. corriente	Terminales	2	11														
L2	1	3	L2	N													
L3	1	3	L3	N													



Un interruptor accesible y señalizado debe encontrarse cerca del dispositivo para apagar la alimentación.

En caso de suministro directo de alimentación > 125 V DC, debe instalarse un fusible externo en el circuito de alimentación.

De lo contrario, deben observarse las condiciones nacionales (por ejemplo, en Alemania, La VDE 0100 "Condiciones de montaje de instalaciones de corriente alta con tensiones por debajo de 1000 V") respecto a la instalación y selección de material para líneas eléctricas!

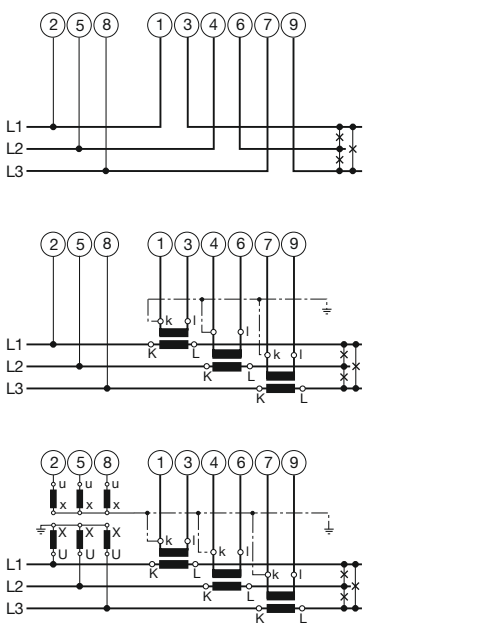
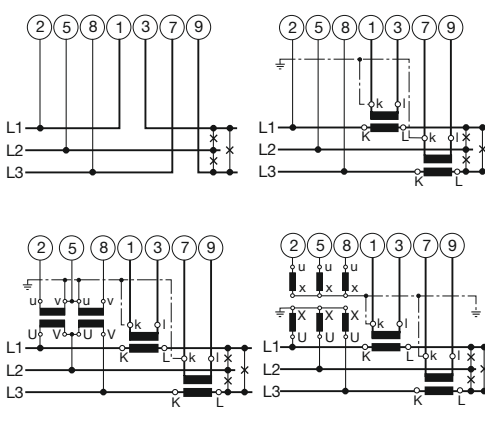
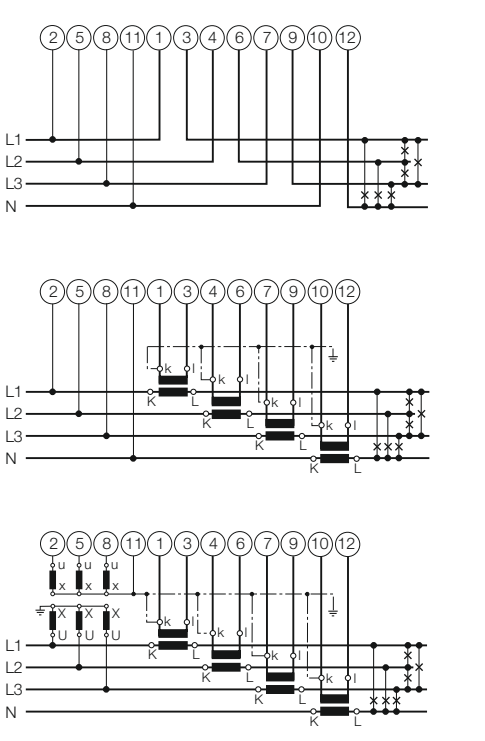
Red / Aplicación	Asignación de terminales
<p>Tres hilos Sistema trifásico desequilibrado</p>	 <p>3 transformadores aislados de tensión de polo único en el sistema de alta tensión</p>
<p>Tres hilos Sistema trifásico desequilibrado Conexión Aron</p>	
<p>Cuatro hilos Sistema trifásico desequilibrado</p>	 <p>3 transformadores aislados de tensión de polo único en el sistema de alta tensión</p>

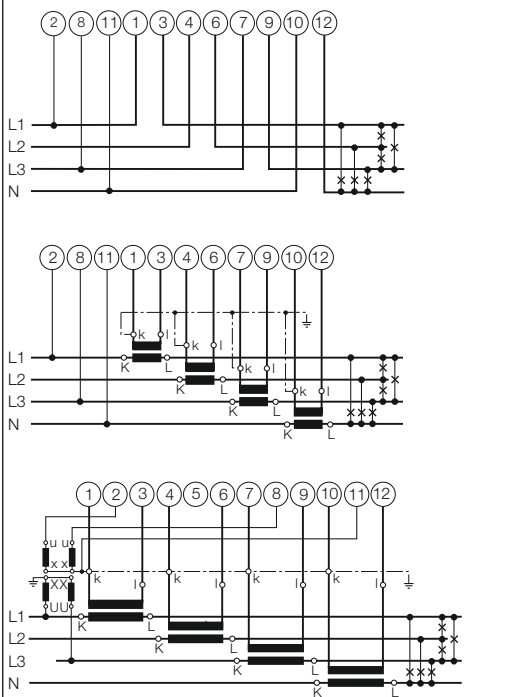
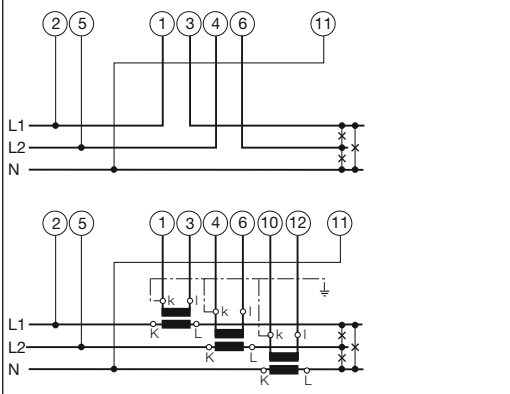
Red / Aplicación	Asignación de terminales
<p>Cuatro hilos Sistema trifásico desequilibrado Conexión en estrella</p>	 <p>2 transformadores aislados de tensión de polo único en el sistema de alta tensión</p>
<p>Fase partida (Red bifásica) desequilibrada</p>	

Esquema dimensional

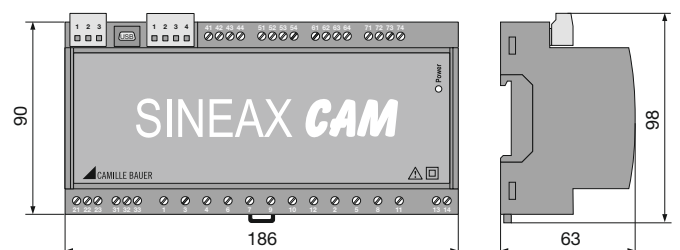

SINEAX CAM en montaje sobre raíl (35 x 15 mm o 35 x 7,5 mm). Los terminales son parcialmente enchufables.

Veiligheidsbepalingen, die absoluut nageleefd moeten worden, zijn in deze handleiding met de volgende symbolen gemarkeerd:

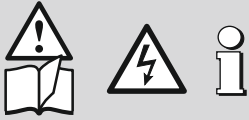

Apparaten moeten volgens de wet afgevoerd worden!

Veiligheidsbepalingen



Camille Bauer Metrawatt AG
Aargauerstrasse 7
CH-5610 Wohlen/Switzerland
Telefon +41 56 618 21 11
Telefax +41 56 618 21 21
info@cbmag.com
www.camillebauer.com

Universele meet-eenheid voor sterkstroomgrootheden SINEAX CAM



156 449-04

09.14

Eerst lezen, daarna ...



Voor een correcte en veilige werking moeten eerst deze veiligheidsinstructies en de gebruiksaanwijzing («Operating Instructions» No. 156 481 of «Betriebsanleitung» Nr. 156 457) zijn **gelezen en begrepen!**

Allen geschoold personeel mag met dit apparaat werken en dient tevens bevoegd te zijn om in elektrische installaties werkzaamheden uit te voeren.

Bij wijzigingen in of aan het apparaat vervalt de garantie!

Leveromvang

SINEAX CAM
1 Veiligheidsbepaling
1 Software- en documentatie CD
1 USB-Kabel

Korte omschrijving

De configureerbare meeteenheid SINEAX CAM is geschikt voor metingen in elektrische wisselstroomnetten. De SINEAX CAM bepaald betrouwbaar de actuele toestand van het net mede doordat er een omvangrijke hogere harmonische analyse beschikbaar is.

De SINEAX CAM is tevens geschikt om sterk "verstoorde" netten te meten zoals fase aangesneden sinussen of achter frequentieregelaars.

Technische specificaties

Meetingang →

Spanning:	57...400V (L-N), resp. 100...693V (L-L)
Stroom:	1...5 A
Nominale frequentie:	50/60 Hz
Aansluit soorten:	Enkelfasig, 3- of 4 leider gelijk of ongelijk belaste netten, Split Phase, 4 kwadranten meting

Voedingsspanning →

Optie 1:	100...230 V AC/DC ± 15%
Optie 2:	24...60 V DC ± 15%
Opgenomen vermogen:	≤ 4...20 VA (afhankelijk van I/O interface)
Groene LED:	Power-On indicatie

Interface ←

Bus-aansluiting:	RS-485 (Modbus protocol), via steek klemmen, max. lengte 1200 m (4000 ft)
USB-aansluiting:	USB 2.0, 5-polig Mini-B

Relais →

Belastbaarheid:	250 V AC, 2 A, 500 VA of 30 V DC, 2 A, 60 W
-----------------	---

I/O-interface

Afhankelijk van de uitvoering staan verschillende klemmengroepen met gedefinieerde in-/uitgangsfuncties ter beschikking. Deze groepen zijn galvanisch gescheiden van elkaar.

Analoge uitgangen →

2x 0/4...20 mA per klemmengroep galvanisch verbonden of
2x ± 20 mA per klemmengroep galvanisch verbonden
Loopspanning 10 V max.
Uitgangselasting 0...500 Ω (max. 20 mA)

Analoge ingangen →

2x 0/4...20 mA per klemmengroep galvanisch verbonden
Ingangsweerstand < 40 Ω

Digitale in-/uitgangen →

3 per klemmengroep, softwarematig als passieve in- of uitgangen configureerbaar (alle gelijk), volgens EN 61131-2
Ingangen 24 V DC (type 3)
Uitgangen 24 V DC, nominale stroom 50 mA (60 mA max.)

Digitale ingangen 125 V DC →

3 per klemmengroep
Ingangen 48 / 125 V DC

HV-Ingang 110 V / 230 V AC →

Spanningsbereik: 0...265 V AC (1,1 x 240 V)
Frequentie: 50...60 Hz
Schakelgrenzen: 40...80 V AC
Ingangsimpedantie: 20 ... 30 kΩ

Bevestiging

De SINEAX CAM wordt op DIN-rail bevestigd.



Men dient er rekening mee te houden dat **de grenzen** van de bedrijfstemperatuur **niet overschreden** worden:

- 10 ... 55 °C

De behuizing op DIN-rail (EN 50 022) bevestigen (zie afbeelding 1).

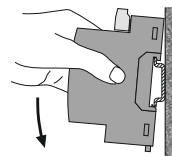

Afbeelding 1. Bevestiging op DIN-rail 35 x 15 of 35 x 7,5 mm.

Demontage-tip

De behuizing volgens afbeelding 2 demonteren vanaf de DIN-rail.

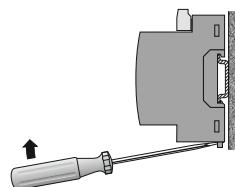

Afbeelding 2

Elektrische aansluitingen

De aansluitingen zijn met schroefklemmen uitgevoerd. Ze zijn geschikt voor bedrading met vaste kern tot 4 mm² of flexibele draad met 2 x 2,5 mm².



Stelt u zeker dat de bedrading spanningsvrij is bij het aansluiten!



Let u erop dat de data aangegeven op het type plaatje aangehouden wordt!

Analoge uitgangen

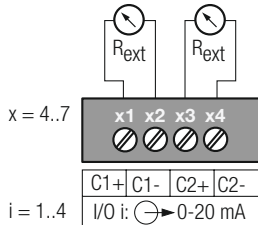

Analoge ingangen

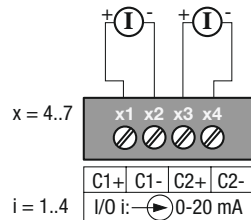

Digitale uitgangen

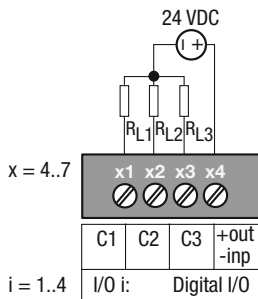

Digitale ingangen

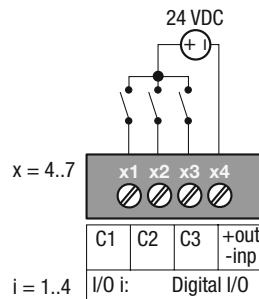

HV-Ingang 110/230 V AC

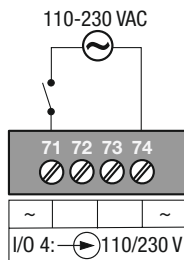

Digitale ingangen 125 V DC

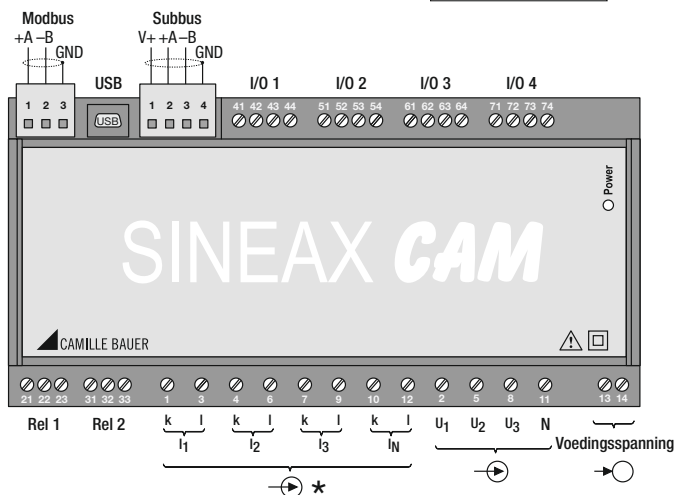
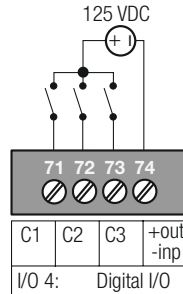

De toestand van de relais-contacten bij een uitgeschaakeld apparaat is niet gedefinieerd. Er kunnen gevaarlijke spanningen op staan.

* Stroomingangen voor Rogowski-spoelen:
Zie gebruiksaanwijzing op CD

Aansluitingen op het net

Soort net / toepassing	Aansluiting															
Enkel fasig wisselstroom-net																
3-leider draaistroom gelijk belast I: L1	<p>Bij stroommeting in L2 resp. L3 is de onderstaande tabel van toepassing:</p> <table border="1"> <thead> <tr> <th>Stroom</th> <th>Klemmen</th> <th>2</th> <th>5</th> <th>8</th> </tr> </thead> <tbody> <tr> <td>L2</td> <td>1</td> <td>3</td> <td>L2</td> <td>L3</td> </tr> <tr> <td>L3</td> <td>1</td> <td>3</td> <td>L3</td> <td>L1</td> </tr> </tbody> </table>	Stroom	Klemmen	2	5	8	L2	1	3	L2	L3	L3	1	3	L3	L1
Stroom	Klemmen	2	5	8												
L2	1	3	L2	L3												
L3	1	3	L3	L1												
4-leider draaistroom gelijk belast I: L1	<p>Bij stroommeting in L2 resp. L3 is de onderstaande tabel van toepassing:</p> <table border="1"> <thead> <tr> <th>Stroom</th> <th>Klemmen</th> <th>2</th> <th>11</th> </tr> </thead> <tbody> <tr> <td>L2</td> <td>1</td> <td>3</td> <td>L2</td> </tr> <tr> <td>L3</td> <td>1</td> <td>3</td> <td>L3</td> </tr> </tbody> </table>	Stroom	Klemmen	2	11	L2	1	3	L2	L3	1	3	L3			
Stroom	Klemmen	2	11													
L2	1	3	L2													
L3	1	3	L3													



Voor het afschakelen van de voedingsspanning is het aan te raden om in de buurt van het apparaat een makkelijk toegankelijke schakelaar toe te passen.

Bij een voedingsspanning > 125 V DC moet een externe zekering toegepast worden.

Voorts zijn de installatievoorschriften per land van toepassing!

Soort net / toepassing	Aansluiting
3-leider draaistroom ongelijk belast	<p>3 enkelpolig geïsoleerde spanningstrafo's in een hoogspanningsnet.</p>
3-leider draaistroom ongelijk belast (Aron schakeling)	
4-leider draaistroom ongelijk belast	<p>3 enkelpolig geïsoleerde spanningstrafo's in een hoogspanningsnet.</p>

Soort net / toepassing	Aansluiting
4-leider draaistroom ongelijk belast (Open-Y schakeling)	<p>2 enkelpolig geïsoleerde spanningstrafo's in een hoogspanningsnet.</p>
Split phase ("2-fasen net") ongelijk belast	

Afmetingen

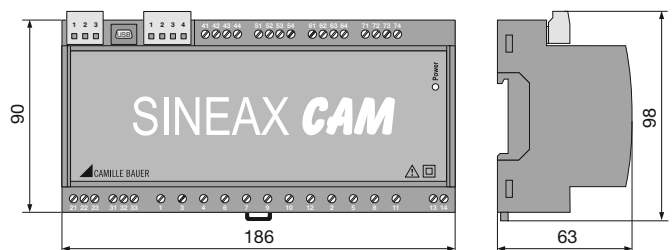

SINEAX CAM in DIN-rail behuizing (35 x 15 mm of 35 x 7,5 mm).
Aansluitklemmen gedeeltelijk steekbaar.