

METRATESTER 5+

Tester for DIN VDE 0701-0702

3-348-580-15
29/5.21





- | | |
|--|--|
| (1) Mains plug
(take-up spool at back of housing
for mains cable) | (6) Connector jack/terminal for testing for
contact current at conductive parts at
the DUT |
| (2) Signal lamp PE for testing the
mains protective conductor | (7) Mains outlet |
| (3) Alligator clips for attachment
to the test probe (3a) | (8) Test socket |
| (3a) Test probe | (9) Connector jack/terminal for DUT
phase conductors (wired parallel
to the socket) |
| (4) Contacting surface for contact finger | (10) Connector jack/terminal for DUT
protective conductor (wired parallel
to test socket) |
| (5) Measuring function selector switch
R_{SL} Protective Conductor Resistance
R_{ISO} Insulation Resistance
I_{EA} Equivalent Leakage Current
I_A Contact or Leakage Current
(for confirmation of absence of voltage)
I_{Diff} Residual Current
I_{Netz} Load current at mains outlet
U_{Netz} Mains Voltage | (11) LCD display (description see page 24) |
| | (12) Carrying handle |
| | (13) Error lamp |

Display

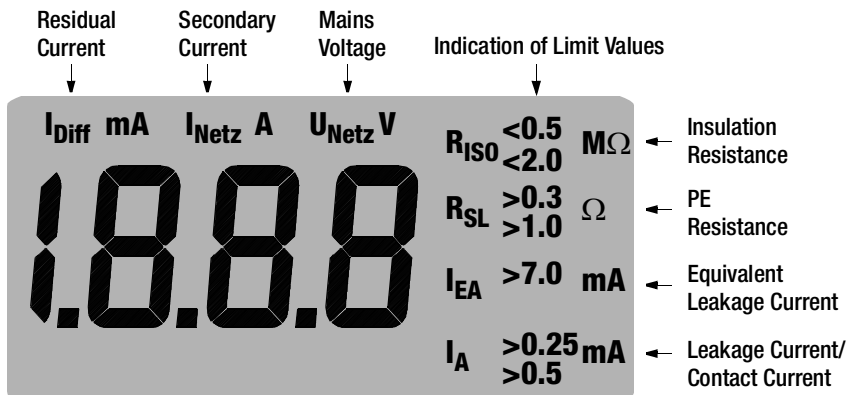

Display text subject to change without notice.

KS 13 Accessory Cable Set

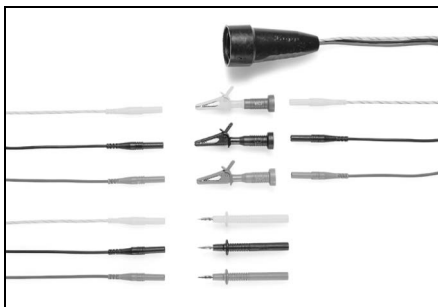

Meanings of Symbols on the Instrument



Continuous, doubled or reinforced insulation



Warning concerning a point of danger (attention: observe documentation!)



Indicates EC conformity



This device may not be disposed with the trash. For further details on the WEEE marking, please refer to our website www.gossenmetrawatt.com and enter search key 'WEEE'.

Contents	Page
1 Safety Features and Precautions	5
2 Applications	6
3 Operating and Display Elements	6
3.1 Error and Limit Value Messages	8
4 Mains Connection	9
4.1 Connecting the Tester	9
4.2 Testing Protective Conductor Potential	10
4.3 Measuring Mains Voltage	10
4.4 Connecting the Device Under Test to the Test Instrument	11
4.4.1 DUT with protective conductor (Safety Class I) and Mains Plug	11
4.4.2 Safety Class II DUT	11
4.4.3 DUT Without Mains Plug or Safety Class III DUT	11
4.4.4 3-Phase DUT	11
4.5 General Measuring Procedures	12
4.6 Residual Current Monitoring	12
5 Testing Devices per DIN VDE 0701-0702	13
5.1 General	13
5.2 Visual Inspection	14
5.3 Measuring Protective Conductor Resistance	14
5.3.1 Special case: permanently connected instruments	15
5.4 Measuring Insulation Resistance	16
5.5 Measurement of protective conductor current	17
5.5.1 Measuring Equivalent Leakage Current	18
5.5.2 Measuring Residual Current	18
5.6 Measuring Contact Current	19
5.6.1 Measuring Equivalent Leakage Current	19
5.6.2 Measuring Residual Current	20
5.6.3 Direct Method	21
6 Measuring Load Current from the Mains Outlet	22
7 Technical Data	23
8 Maintenance – Calibration	26
9 Repair and Replacement Parts Service Calibration Center and Rental Instrument Service	27
10 Product Support	28

1 Safety Features and Precautions

The tester is manufactured and tested in accordance with the following standards:

IEC/EN 61010-1/VDE 0411-1 Safety regulations for electrical measuring, control, regulating and laboratory devices – general requirements

and

DIN VDE 0404-1/-2: Testing and measuring equipment for checking the electric safety of electric devices; Part 1: general requirements, and Part 2: Testing equipment for tests after repair, change or in case of repeat tests

When used for its intended purpose, the safety of the user, the test instrument and the device under test (electrical equipment) is assured.

Read the operating instructions carefully and completely before placing your test instrument into service, and follow all instructions contained therein. Make sure that the operating instructions are available to all users of the instrument.

The tests may only be conducted under the supervision of a qualified electrician. The user must be instructed by a qualified electrician in the performance and evaluation of the test.

Observe the following safety precautions:

- The instrument may only be connected to electrical supply systems with 230 V/240 V which conform to the valid safety regulations (e.g. IEC 60364, VDE 0100) and are protected with a fuse or circuit breaker with a maximum rating of 16 A.
- No measurements within electrical systems are allowed.
- Be prepared for the occurrence of unexpected voltages at devices under test. For example, capacitors may be dangerously charged.
- Make certain that connector cables are not damaged, e.g. damaged insulation, interruptions etc.



Attention!

Devices under test may only be connected to the mains outlet after they have successfully completed safety testing in accordance with DIN VDE 0701-702!

Opening of Equipment / Repair

The equipment may be opened only by authorized service personnel to ensure the safe and correct operation of the equipment and to keep the warranty valid.

Even original spare parts may be installed only by authorized service personnel.

In case the equipment was opened by unauthorized personnel, no warranty regarding personal safety, measurement accuracy, conformity with applicable safety measures or any consequential damage is granted by the manufacturer.

Repair, Parts Replacement and Balancing

Voltage conducting parts may be exposed when the device is opened. The device must be disconnected from all sources of voltage before repair, replacement of parts or balancing. If repair or balancing of an open, live device cannot be avoided, this may only be performed by trained personnel who are familiar with the dangers involved.

Errors and Extraordinary Strains

If it may be assumed that the device can no longer be operated safely, it must be removed from service and secured against unintentional use. Safe use can no longer be relied upon,

- if the device demonstrates visible damage,
- if the device no longer functions,
- after lengthy periods of storage under unfavorable conditions.

2 Applications

The tester is intended for the testing and measurement of repaired or modified electrical devices in accordance with DIN VDE 0701-702. These regulations require the measurement of protective conductor resistance, insulation resistance and equivalent leakage current for repaired or modified electrical devices, as well as testing for the absence of voltage at exposed, conductive parts for data processing systems and office machines.

Testing for the absence of voltage at the mains connection protective conductor and line voltage measurements can also be performed with this instrument. The device under test can be connected to mains power at the mains outlet integrated into the tester, which provides for the measurement of power consumption and the testing of functions.



Note!

Limit values displayed at the instrument make reference to periodic testing requirements set forth in VDE 0702: 1995.

3 Operating and Display Elements

(1) Mains Plug

The tester is connected to the 230 V mains outlet with the mains plug. If no earthing contact socket is available, or if only three-phase current is available, the KS13 cable set can be used to establish a connection.

The mains connection must be fused. Maximum nominal rating: 16 A!

(2) PE Signal Lamp for Protective Conductor Testing

The PE signal lamp lights up, if a potential difference of ≥ 100 V occurs between the contacting surface (4) and the earthing contact at the mains plug (1).

(3) Alligator clip (gripper clip for attachment to the test probe)

Connect the housing of the device under test with the alligator clip for measurement of protective conductor resistance.

(4) Contacting Surface for Contact Finger

The PE signal lamp (2) lights up, if a potential difference of ≥ 100 V occurs between the PE protective conductor at the mains plug (1) and the contacting surface.

The contacting surface is electrically isolated from all terminals, as well as from the measuring circuit, and thus conforms to protection class III!

(5) Measuring Function selector Switch

Measuring functions can be selected with the measuring function selector switch. Displayed values at intermediate switch positions have no significance.

(6) Connector Jack/Terminal for Measurement of Contact Current at Conductive Components at the Device Under Test

This terminal is intended for the measurement of contact current at exposed conductive parts which are not connected to the protective conductor.

(7) Mains Outlet

The DUT can be connected to the integrated mains outlet for the measurement of power consumption and functions testing.

Residual current measurement is performed in this way as well.

Overcurrent protection is provided by the mains fuse or circuit breaker, see (1).

(8) Test Socket

The DUT is connected to the test socket for the measurement of protective conductor resistance, insulation resistance and equivalent leakage current in accordance with DIN VDE 0701-0702, if the DUT is equipped with a mains plug.

(9) Connector Jack/Terminal for DUT Phase Conductors

This terminal is wired in parallel to the two short-circuited phase conductor terminals at the test socket (8). The DUT phase conductors can be connected to this jack/terminal, if the DUT is not equipped with a mains plug.

(10) Connector Jack/Terminal for DUT Protective Conductor

This terminal is wired in parallel to the protective conductor terminal at the test socket (8). The DUT protective conductor can be connected to this jack/terminal, if the DUT is not equipped with an earthing contact plug. Beyond this, exposed conductive parts at the device under test must be connected to this jack for insulation testing and the measurement of equivalent leakage current.

(11) LCD Display

Measured values are displayed in digital form at the LCD.

(12) Carrying Handle

The carrying handle can be folded out.

(13) Error Lamp

The red error lamp indicates that limit values have been exceeded during the measurement of protective conductor and insulation resistance, equivalent leakage, contact and leakage current, as well as residual current.

KS 13 Accessory Cable Set

The KS 13 cable set consists of a adapter socket with three permanently connected cables, 3 measurement cables, 3 plug-on pick-off clips and 2 plug-on test probes. With the KS 13 the tester and the DUT can be connected, even if no earthing contact socket is available for the mains connection, or no earthing contact plug is present at the DUT.

3.1 Error and Limit Value Messages

Error Message	Condition	PE Signal Lamp
Protective conductor potential, at mains	$U_B > 100 \text{ V}$	If contact surface is contacted

The following limit values are indicated

Measurement	Error Condition per Standard	Test Instrument Indicates When Limit Values Are Exceeded		
		Red Error Lamp Continuously Lit	Limit Values are Displayed	Continuous Acoustic Signal (Beeper)
Protective Conductor Resistance	$R_{SL} > 0.3 \Omega$ ¹⁾	•	$> 0.3 \Omega$	—
	$R_{SL} > 1 \Omega$ ²⁾	•	$> 1 \Omega$	•
Insulation Resistance	Heating ³⁾ : $R_{ISO} < 0.3 \text{ M}\Omega$	•	$< 0.5 \text{ M}\Omega$ ⁴⁾	•
	SCI: $R_{ISO} < 1.0 \text{ M}\Omega$	•	$< 2.0 \text{ M}\Omega$	—
	SCII: $R_{ISO} < 2.0 \text{ M}\Omega$	—	$< 2.0 \text{ M}\Omega$	—
Equivalent Leakage Current	$I_{EA} > 3.5 \text{ mA}$	•	—	—
		•	$> 7.0 \text{ mA}$ ⁵⁾	•
Leakage/Contact Current (Substantiation of Absence of Voltage)	Part 240: $I_A > 0.25 \text{ mA}$	•	$> 0.25 \text{ mA}$	—
	$I_A > 0.5 \text{ mA}$	•	$> 0.5 \text{ mA}$	•
Residual Current	$I_{Diff} \geq 3.5 \text{ mA}$	•	—	•

¹⁾ Resistance between housing and mains plug in connector cables up to a length of 5 m

²⁾ For extension cables, there is an additional resistance of 0.1Ω for each additional 7.5 m, up to a maximum, however, of 1Ω

³⁾ For safety class I devices with activated heating elements (if heating power $> 3 \text{ kW}$ and $R_{ISO} < 0.3 \text{ M}\Omega$: leakage current measurement required)

⁴⁾ Limit value per DIN VDE 0702:1995

⁵⁾ This limit value applies for all-pole switches (corresponds to a doubling of the limit value or, respectively, a 50 % reduction of the actual measuring current)

Residual Current Limit Value Violations

The METRATESTER 5 is equipped with a **selector switch independent, residual current monitoring** function. If the red error lamp lights up and no message regarding a limit value violation appears at the display, residual current at the mains outlet is dangerously high – regardless of the selector switch setting. If this is the case, it is advisable to measure residual current (differential current) by turning the selector switch to the “ I_{DIFF} ” position.

Only the displayed numeric value should be considered when **evaluating residual current** with the selector switch in the “ I_{DIFF} ” position. The error lamp may be caused to light up as a result of residual current monitoring for values of as low as approximately 3.2 mA. The error lamp lights up in any case as of 3.5 mA.

4 Mains Connection

4.1 Connecting the Tester

- Connect the tester to the 230 V mains with the mains plug (1). If no earthing contact socket is available, or if only a three-phase socket is available, connection of the phase conductors, the neutral conductor and the PE conductor can be accomplished with the help of the adapter socket. It includes 3 permanently connected cables and is included with the KS 13 accessory cable set.

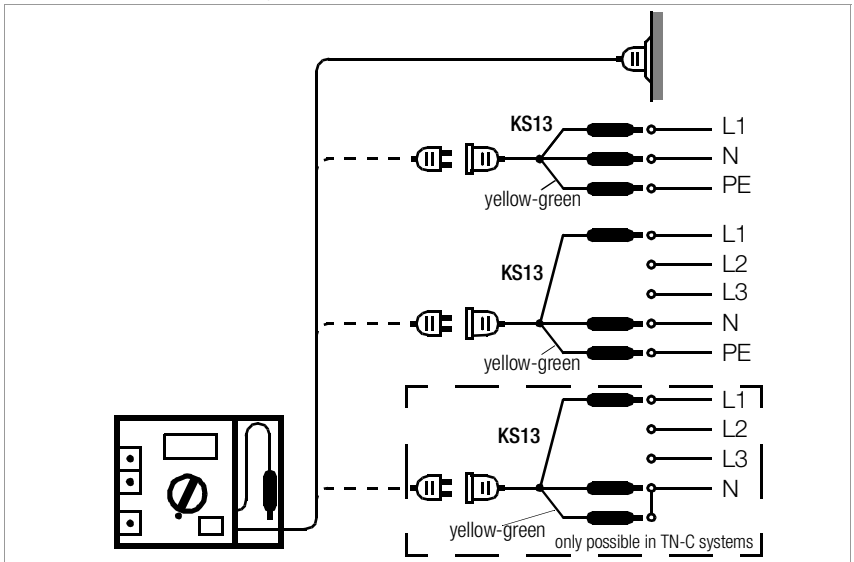

Attention!

The instrument may only be connected to electrical supply systems with 230 V/ 240 V which conform to the valid safety regulations (e.g. IEC 60364, VDE 0100) and are protected with a fuse or circuit breaker with a maximum rating of 16 A.

The pick-off clips on the cables at the adapter socket may only be connected in the voltage-free condition!

If mains voltage is present, characters are displayed at the LCD regardless of the position of the measuring function selector switch, even if no DUT has been connected. Thus the presence of characters at the display indicates the presence of voltage – independent of measuring function selector switch position.

The mains voltage value is indicated at the display in the “U_{Netz} 250 V” selector switch position. In all other switch detent positions, characters are displayed which have no correlation to a measured value, if a DUT has not been connected.

4.2 Testing Protective Conductor Potential

- ⇨ Bring the contact finger into contact with the contacting surface (4) and, at the same time, with a grounded object (e.g. a water pipe).
The PE signal lamp (2) must not light up! Potential between the mains plug protective conductor (1) and the contacting surface (4) is then ≤ 100 V.



Note!

The PE signal lamp (2) does not light up, if no mains voltage is present between L and N at the mains plug (1), or if L and PE are reversed at the mains connection. If, after having connected the DUT in accordance with chapter 4.1, page 9, you determine, that no characters are displayed at the LCD, the mains connection should first be inspected – e.g. with the **PROFITEST MASTER** tester.

However, if the PE signal lamp (2) lights up when contact is made with the contacting surface (4), potential between the protective conductor at the mains plug (1) and the contacting surface (4) is > 100 V, i.e. voltage is present at the protective conductor or the protective conductor is not connected.



Note!

Stray voltages may occur due to handling of the DUT, which cause the PE signal lamp (2) to light up. For example, this may occur if a device is held in the hand which has been connected to the test socket (8) due to the resultant occurrence of a capacitive voltage divider. Touch a grounded object as described above in this case.



Attention!

Voltage at the mains protective conductor (phase conductor L at protective earth conductor PE: incorrect wiring of mains socket) also distorts measured values for the following tests:

- Measurement of contact current per DIN VDE 0701-0702
 - Residual current measurement
-

4.3 Measuring Mains Voltage

- ⇨ Set the measuring function selector switch to “U_{Netz} 250 V”
- ⇨ Read the measured value at the LCD.
Mains voltage must lie within the allowable range of 207 to 253 V.

4.4 Connecting the Device Under Test to the Test Instrument

The DUT must be connected to the test socket (8), or to the jacks or terminals (9 and 10) which are connected in parallel to the test socket for the measurement of **protective conductor resistance**, **insulation resistance** and **equivalent leakage current**. Terminal (9) is connected to the short-circuited phase conductor jacks at the test socket (8), and terminal (10) is connected to the earthing contact at the test socket (8). Use one of the following test setups, depending upon the type of device under test.

4.4.1 DUT with protectiv conductor (Safety Class I) and Mains Plug

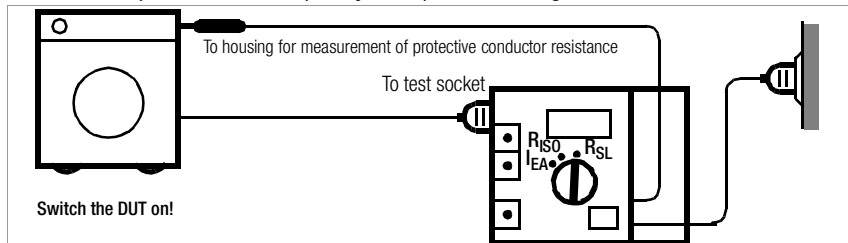

4.4.2 Safety Class II DUT

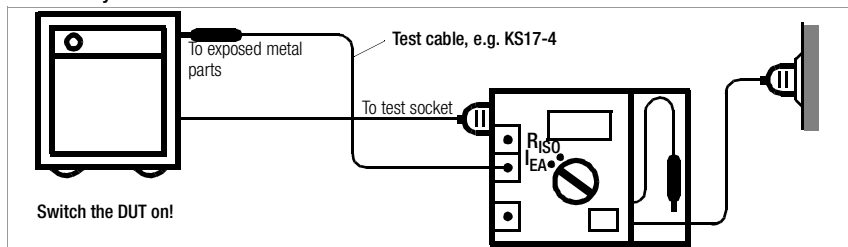

4.4.3 DUT Without Mains Plug or Safety Class III DUT

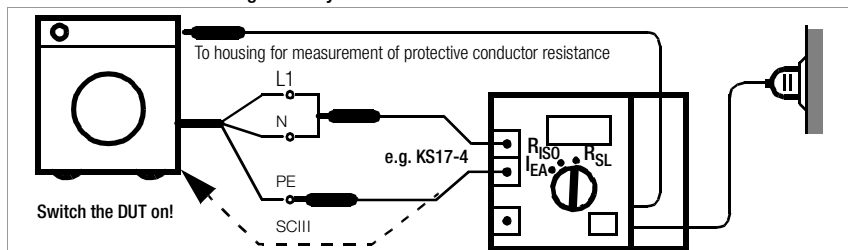

4.4.4 3-Phase DUT

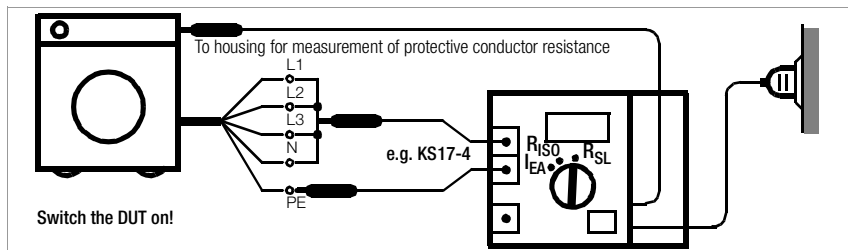

4.5 General Measuring Procedures

Line voltage must lie within the allowable range of 207 to 253 V for all of the following measurements. This assures that the accuracy of displayed measured values corresponds with the values specified under "Technical Data" (chapter 7, page 23).

Line voltage can be measured by setting the measuring function selector switch to the "U_{Netz} 250 V" position (see chapter 4.3, page 10).

Measuring ranges for the measurement of protective conductor resistance, insulation resistance, equivalent leakage current and contact current are protected against overload in the event that interference voltages of up to 250 V are applied inadvertently.

Always start with the measurement of protective conductor resistance for safety class I devices. Insulation resistance and equivalent leakage current cannot be measured if the protective conductor does not function properly. This connection must be established externally for safety class II devices (see chapter 4.4.2).



Note!

Please note that overflow is indicated at the display during the measurement of protective conductor resistance and insulation resistance, if the terminals are open or if the upper range limit is exceeded. In this case, only the character "1" is displayed at the left-hand side of the LCD (11).



Attention!

Measuring current is reduced after approximately 10 minutes in the event of a long-term short-circuit during insulation testing. Excessive temperature is indicated at the display in this case (see chapter 7 "Display – Excessive Temp."). If this display appears, nominal current of 1 mA as required by DIN VDE 0413 is no longer assured. After the short-circuit has been eliminated, and after a brief cool-down period, the message is cleared from the display and subsequent measurements once again fulfill VDE requirements.

Evaluating Measured Values

In order to make absolutely sure that limit values for insulation resistance are not fallen short of, instrument measuring error must be taken into consideration. Minimum required display values for insulation resistance can be taken from the following table. These values take maximum service error into consideration (under nominal conditions of use). The indicated values correspond to the required limit values (DIN VDE 0413, part 1). Intermediate values can be interpolated.

Limit Value M Ω	Minimum Display Value
0,25	0,33
0,3	0,38
0,5	0,60
1,0	1,15
2,0	2,25
7,0	7,75
10,0	11,05

4.6 Residual Current Monitoring

For your safety, residual current at the DUT connected to the mains outlet is continuously monitored by METRATESTER 5 instruments. If residual current reaches a value of greater than 3.5 mA, danger is indicated by means of a continuous acoustic signal.

Automatic shutdown does not occur (see chapter 3.1, page 8).

5 Testing Devices per DIN VDE 0701-0702

The limit values specified in the following chapters correspond to current revision levels of official standards at the time of going to print. Please note that normative legislation is continuously updated to meet the safety requirements necessitated by changing market situations, and that the listed limit values are thus subject to change. Please contact our update service department in order to adapt test instruments to new standards.

5.1 General

According to DIN VDE 0701-0702, repaired or modified electrical devices must provide users with the same protection against electrical energy as is offered by new devices. The following tests must be performed to this end, in the order indicated:

- 1 Visual inspection
- 2 Protective conductor resistance
- 3 Insulating characteristics:
if technically sensible, i.e. if the DUT does not include any all-pole, electrically actuated switches:
 - Insulation resistance followed by protective conductor current or equivalent leakage current
 - Other: leakage current during operation (protective conductor current and contact current), safety extra-low voltage (only at connecting points for safety extra-low voltage generated within the device under test)
- 4 Function test
- 5 Labelling inspection
- 6 Documentation



Attention!

If any doubts exist concerning the performance of an insulation resistance measurement, a differential current measurement can be performed in its place. For example, this may be the case with electronic devices and data processing equipment, or safety class I devices if it is assured that all components which are charged with line voltage are covered by this measurement.

This measurement may only be performed after the protective conductor at the DUT has been tested.

The device under test must be plugged into the **mains outlet** at the METRATESTER 5 test instrument for measurement of residual current.



Note!

An RCCB may be tripped if measurement is performed at a defective device!

5.2 Visual Inspection

Visual inspection is performed prior to measurements with the test instrument.

Visual inspection includes:

- damage to connector cables;
- insulation damage;
- selection and application of conductors and plugs for their intended use;
- condition of mains plug, of connection terminals and wires;
- defects of bending protection;
- defects of connector cable strain relief;
- condition of fastenings, of conductor fixings, of the fuse holder which is accessible to the user, etc.;
- damage to the housing and protective covers;
- signs of excessive strain or improper use/handling;
- signs of inadmissible tampering or modifications;
- fouling, corrosion or aging to a degree unduly impairing the safety of the instrument;
- fouling and/or clogging of openings for cooling purposes;
- condition of air filters;
- leakproofness of containers for water, air or other agents/fluids, condition of pressure control valves;
- operation of switches, control and/or setting equipment, etc.;
- legibility of safety labels or symbols, of rated values and position indicators.

5.3 Measuring Protective Conductor Resistance

- ⇒ In the case of instruments equipped with a protective conductor, connect the DUT as described in the following picture.

here: dut (Safety class I) and mains plug, also see chapter 4.4, page 11.

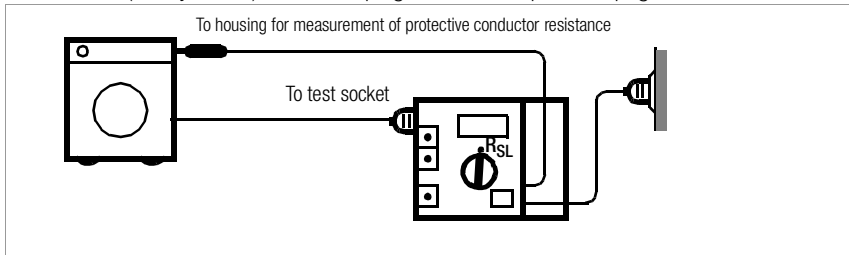

- ⇒ Set the measuring function selector switch to the "R_{SL} 20 Ω" position.
- ⇒ Read the measured value in "Ω" from the LCD
- ⇒ Move the cable from the DUT during the measurement, section by section over its entire length, in order to locate interruptions.

Protective conductor resistance may not exceed the following values:

Maximum Allowable Protective Conductor Resistance Values Depending upon Cable Length

Length to [m]	5	12.5	20	27.5	35	42.5	50	more than 50
Max. resistance [Ω]	0.3	0.4	0.5	0.6	0.7	0.8	0.9	1.0

Under no circumstances may a value of 1 Ω be exceeded. The table is also valid for cable reels and extension cables.



Attention!

The alligator clip (3) must make good contact with the housing of the device under test!

The connector cable must be moved during measurement, section by section over its entire length – for permanently installed devices only in so far as the cable is accessible during repair, modification or testing. If the resistance value fluctuates during this manual test which is essential for continuity testing, it must be assumed that the protective conductor is damaged, or that one of its connection points is defective. Defects of this type must be corrected before any further tests are performed.

5.3.1 Special case: permanently connected instruments

A resistance value of up to 1 Ω measured between a suitable earthing contact and all exposed conductive parts which might become charged with voltage in the event of an error is allowable for permanently installed devices.

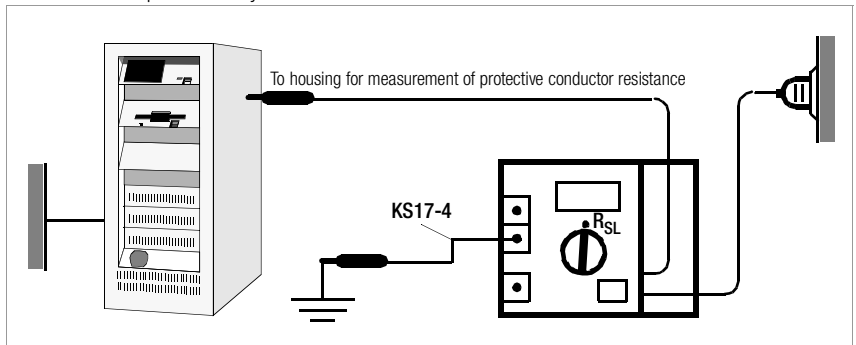

In the case of data processing systems or combinations of permanently installed individual devices, the network should be decoupled and individual measurements should be performed. If decoupling is not feasible, individual measurements may be performed at interconnected devices.

5.4 Measuring Insulation Resistance

This measurement may only be performed if the device under test has successfully completed protective conductor resistance testing. If the DUT is equipped with all-pole electrical switches, e.g. undervoltage releases or relays, this test only covers the supply conductor. The device cannot be switched on without being connected to the mains, consequently, it cannot be subjected to an effective insulation test. For testing in conformance with VDE, it is necessary to measure the leakage current under mains voltage.



Attention!

Do not touch the instrument's terminal contacts during insulation resistance measurements!

If nothing has been connected to the terminal contacts, or if a resistive load component has been connected for measurement, your body would be exposed to a current of approx. 1 mA at a voltage of 500 V. The resulting electrical shock is not life endangering. However, the noticeable shock may lead to injury (e.g. resulting from a startled reaction etc.).



Attention!

If measurement is performed at a capacitive object such as a long cable, it becomes charged with up to approx. 500 V! **Touching such objects is life endangering!**

➤ Connect the DUT as shown in the following picture

Safety Class I

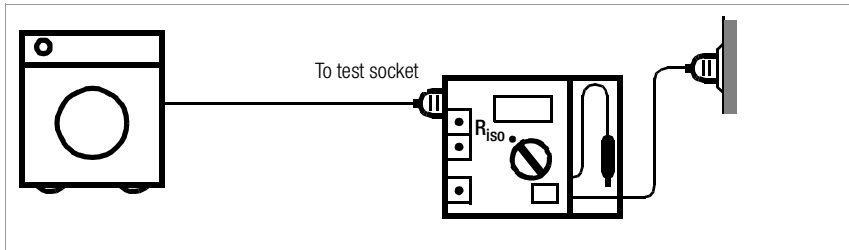

Safety Class II

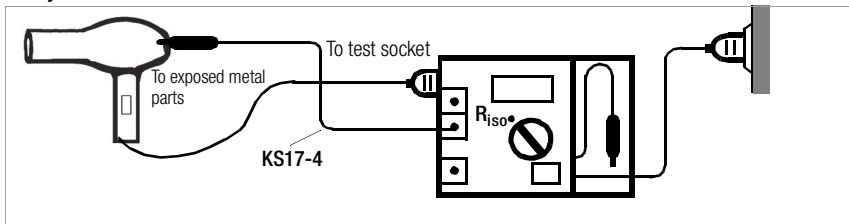

- Set the measuring function selector switch to the "R_{ISO} 20 MΩ" range.
- Activate all functions of the DUT, and be certain, for example, that contacts for temperature sensitive switches and the like are also closed.
- Read the measured value in "MΩ" from the LCD (11).
Insulation resistance may not fall short of the following values:

Device Type	Limit Value	Minimum Display Value
Safety class I devices	1 M Ω	1.15 M Ω
Safety class I devices with heating elements	0.3 M Ω ¹⁾	0.38 M Ω
Safety class II devices	2.0 M Ω	2.25 M Ω
Safety class III devices and battery powered devices	1000 Ω /V or 250 k Ω	

¹⁾ Leakage current measurement must be performed if the applicable limit value is fallen short of.

Note: „OL“ means measured value > 20 M Ω .



Attention!

If a value of 0.3 M Ω is fallen short of for safety class I devices with heating elements, equivalent leakage current measurement must be performed and passed in accordance with chapter 5.6.1, page 19.

Each exposed conductive part must be contacted with the test probe connected to the jack (10), and insulation resistance must be measured for safety class II and III devices, and battery powered devices.

No insulation resistance measurement is required for safety class III devices, or for battery powered devices which fulfill both of the following conditions:

- Nominal power \leq 20 VA
- Nominal voltage \leq 42 V.

Batteries must be disconnected during the performance of measurements at battery powered devices.

Discharge of the DUT for the avoidance of electrical shocks

➤ After insulation resistance measurement on capacitive objects:

Set the measuring function selector switch one position further to the left to switch position „I_{EA} 20 mA“, in accordance with the standard-compliant test sequence. The DUT is automatically discharged. Contact with the device under test must be maintained to this end.

5.5 Measurement of protective conductor current

Protective conductor current must be measured in instruments featuring a protective conductor/earth-contact plug.

The following methods may be used for measurement:

- Measuring Equivalent Leakage Current
- Measuring Residual Current

Frequency response is taken into consideration in accordance with the graph to the right during leakage current measurement.

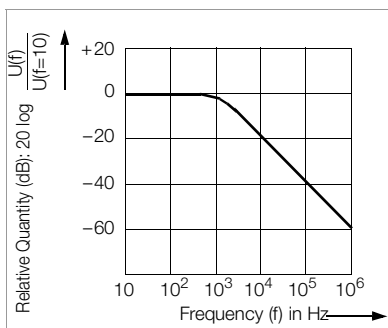

Note!

The following schematic diagrams refer to DUTs with a mains plug. See also chapter 4.4

5.5.1 Measuring Equivalent Leakage Current



Attention!

Do not touch the instrument's terminal contacts during equivalent leakage current measurements!

- Connect the DUT as shown in the following picture.

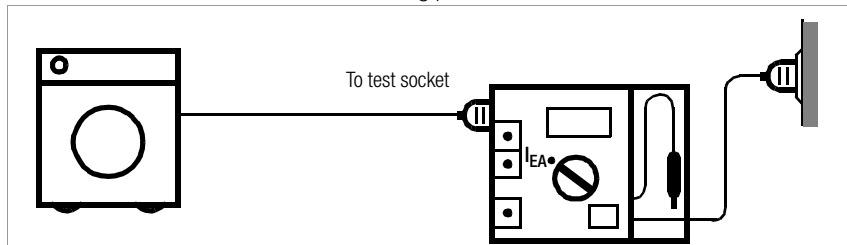

- Set the measuring function selector switch to the " I_{EA} 20 mA" position.
- Switch all DUT functions on and make sure, for example, that all contacts for temperature sensitive switches and the like are closed.
- Read the measured value in "mA" from the LCD.
According to DIN VDE 0701-0702, the displayed value for current between components to which voltage is applied during operation and exposed metal parts may not exceed 3.5 mA, or 1 mA/kW for devices with heating power of greater than 3.5 kW.

5.5.2 Measuring Residual Current

Residual current (differential current) is measured between phase conductor L and neutral conductor N at the device under test. This measurement may not be performed until the protective conductor test has been passed (see chapter 5.3, page 14).

- Connect the device under test to the mains outlet..

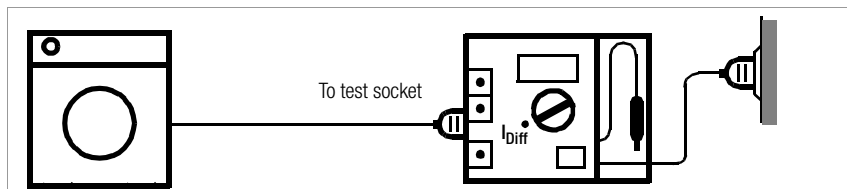

- Set the measuring function selector switch to the " I_{Diff} 20 mA" position.
- Start up the device under test.
- Read the residual current value in mA from the display. According to DIN VDE 0701-0702, the displayed current value may not exceed 3.5 mA, or 1 mA/kW for devices with heating power equal to or greater than 3.5 kW.

Measurements must be performed with the mains plug poled in both directions. The larger of the two measured values applies.



Note!

If no device under test is connected, random characters appear at the digital display which may not be construed as measured values.



Note!

If the METRATESTER 5 is integrated into a 3-phase ammeter, residual current is measured as the sum of instantaneous current in conductors L1, L2, L3 and N.

5.6 Measuring Contact Current

Contact current measurement can be performed instead of insulation resistance measurement for class II devices, or for class I devices with exposed conductive parts which are not connected to the protective conductor.

- Measuring Equivalent Leakage Current
- Measuring Residual Current
- Direct Method

Frequency response is taken into consideration in accordance with the graph to the right during leakage current measurement.

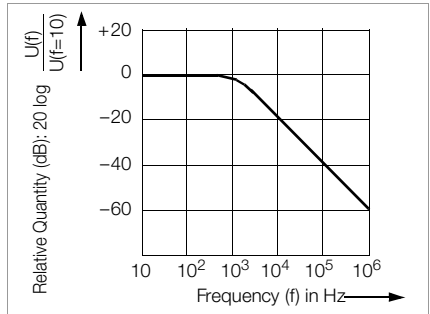

Note!

Please note that the current in the protective conductor is also measured both in the case of equivalent leakage current and in the case of differential current measurement.



Note!

The following schematic diagrams refer to DUTs with a mains plug. See also chapter 4.4

5.6.1 Measuring Equivalent Leakage Current



Attention!

Do not touch the instrument's terminal contacts during equivalent leakage current measurements!

- ◇ Connect the DUT as shown in the following picture.

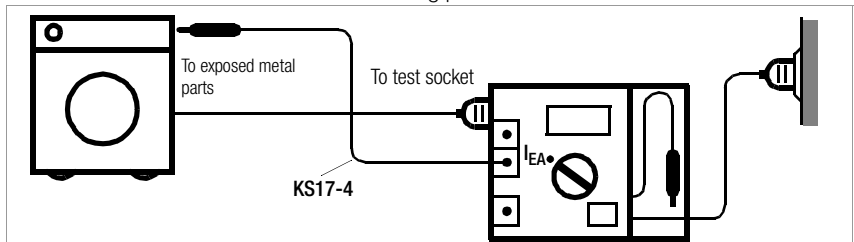

- ◇ Connect the cable with the test probe to the "SL" jack.
- ◇ Set the measuring function selector switch to the "I_{EA} 20 mA" position.
- ◇ Switch all DUT functions on and make sure, for example, that all contacts for temperature sensitive switches and the like are closed.
- ◇ Contact all exposed metal parts at the device under test with the test probe.
- ◇ Read the measured value in "mA" from the LCD.
This value may not exceed 0.5 mA

5.6.2 Measuring Residual Current



Attention!

The protective conductor test must first be performed and passed.

- Connect the DUT as shown in the following picture..

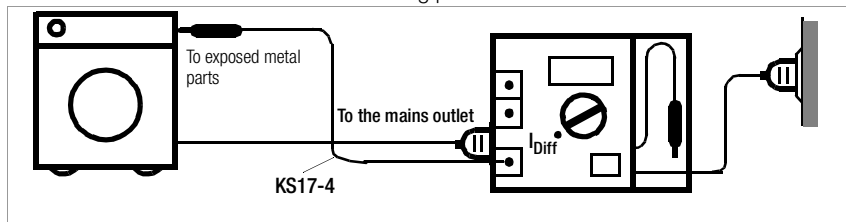

- Connect the cable with the test probe to the “2 mA” jack.
- Set the measuring function selector switch to the “I_{Diff} 20 mA” position.
- Start up the device under test.
- Contact all exposed metal parts at the device under test with the test probe.
- Read the residual current value in mA from the display. This value may not exceed 0.5 mA.

Measurements must be performed with the mains plug poled in both directions. The larger of the two measured values applies.



Note!

If no device under test is connected, random characters appear at the digital display which may not be construed as measured values.

5.6.3 Direct Method

The DUT can remain connected to the mains or to the mains outlet for this test. When testing in accordance with DIN VDE 0701-0702, DUTs with external connections such as data cables etc. can be tested within their entire configuration at the installation site.



Note!

An RCCB may be tripped if measurement is performed at a defective device!

- Connect the DUT as shown in the following picture.

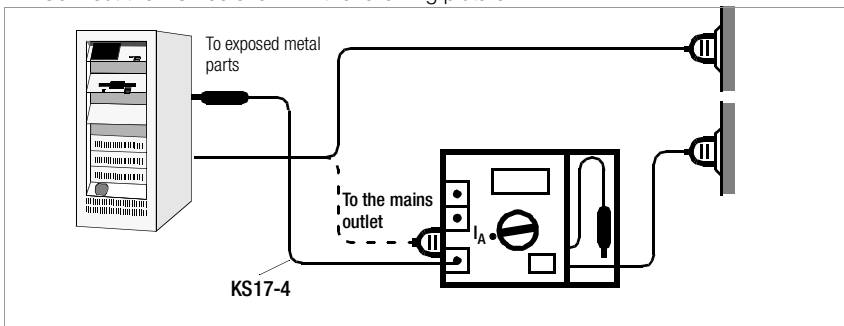

- Connect the cable with the test probe to the “2 mA” jack.
- Set the measuring function selector switch to the “I_A 2 mA” position.
- Start up the device under test.
- Contact all exposed metal parts at the device under test with the test probe.
- Read the residual current value in mA from the display. This value may not exceed 0.5 mA.

6 Measuring Load Current from the Mains Outlet

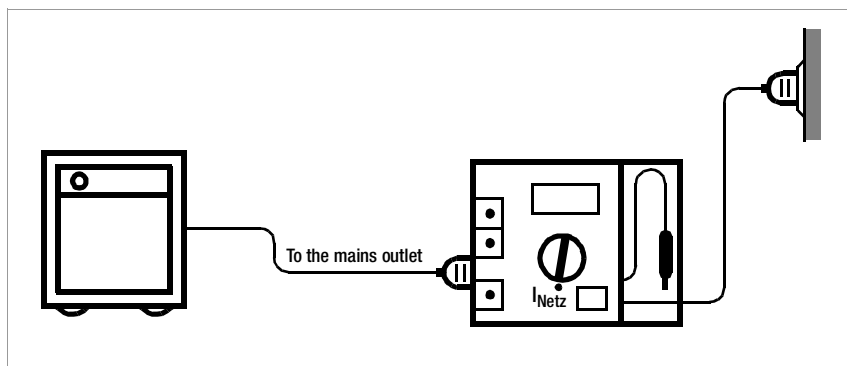

Attention!

The device under test may not be connected to the mains outlet (7) until it has passed safety testing in accordance with DIN VDE 0701-0702, part 1!

- Connect the earthing contact plug from the device under test to the mains outlet (7).
- Set the measuring function selector switch to the "I_{Netz} 16 A" position.
- Switch the device under test on.
- Read the measured value in "A" from the LCD (11).



Attention!

Maximum allowable load capacity is 16 A continuous and 20 A for up to 10 minutes. The electrical system to which the test instrument is connected must be protected against overload with a fuse or circuit breaker. The fuse or circuit breaker rating may not exceed 16 A!

7 Technical Data

Meas. Quantity	Measuring Range	Resolution	$U_{NO-LOAD}$	R_i	I_K	I_N
PE Resistance	0 ... 19.99 Ω	10 m Ω	< 20 V –	—		> 200 mA
Insulation Resistance	0,05 ... 19.99 M Ω	10 k Ω	600 V –	approx. 100 k Ω	< 10 mA	> 1 mA
Equivalent Leak. Current	0 ... 19.99 mA ~	10 μ A	28 V ~	2 k Ω	< 20 mA	—
Confirmation of absence of voltage with current measurement (contact or leakage current)	0 ... 1.999 mA ~	1 μ A		2 k Ω		
Residual Current	0.01 ... 19.99 mA ~	10 μ A				

Operational Measurements

Meas. Quantity	Measuring Range	Resolution
Mains Voltage	207 ... 253 V ~	1 V
Load current at mains outlet	0 ... 16.00 A ~	10 mA

Overload Capacity

Load current at mains outlet, residual current	19 A, 5 min.
All other measuring quantities	250 V continuous

Intrinsic and Measuring Uncertainty

Meas. Quantity	Intrinsic Uncertainty	Measuring Uncertainty
Protective Conductor Resistance	\pm (2.5 % of rdg. + 2 D)	\pm (10 % of rdg. + 5 D)
Insulation Resistance 0 ... 19.99 M Ω	\pm (2.5 % of rdg. + 2 D)	\pm (10 % of rdg. + 5 D)
Equivalent Leakage Current	\pm (2.5 % of rdg. + 2 D)	\pm (10 % of rdg. + 5 D)
Confirmation of absence of voltage with current measurement (contact current)	\pm (2.5 % of rdg. + 2 D)	\pm (10 % of rdg. + 5 D)
Residual Current	\pm (4 % of rdg. + 5 D)	\pm (10 % of rdg. + 5 D)
Mains Voltage	\pm (2.5 % of rdg. + 2 D)	\pm (10 % of rdg. + 5 D)
Load current at mains outlet	\pm (2.5 % of rdg. + 2 D)	\pm (10 % of rdg. + 5 D)

Reference Conditions

Ambient Temperature	+23 °C \pm 2 K
Relative Humidity	40 ... 60%
Mains Voltage	230 V \pm 1 %
Measured Quantity Frequency	50 Hz \pm 0.2%
Measured Quantity Waveshape	sine (deviation between effective and rectified value \pm 0.5%)

Influence Variables and Errors

Influence Variable/ Sphere of Influence	Designation per DIN VDE 0404	Influence Errors ± ... % of measured value
Change in position	E1	—
Change in supply voltage to the test device	E2	2.5
Temperature fluctuation 0 ... 21 °C and 25 ... 40 °C	E3	Indicated influence errors per 10 K temperature change: 1 with PE resistance 0.5 all other measuring ranges
Current at device under test	E4	2.5
Low frequency magnetic fields	E5	2.5
DUT impedance	E6	2.5
Capacitance during insulation measurement	E7	2.5
Waveshape of the measured current	E8	
49 ... 51 Hz		2 with capacitive load (with equivalent leakage current)
45 ... 100 Hz		1 (with contact current)
		2,5 all other measuring ranges

Display and Signalling Devices

LCD

Display Range	0 ... 1999 digits, 3½ places
Character Height	17 mm and special characters
Overflow	indicated at display with "OL"
Excessive Temp. R_{ISO}	for long duration short-circuit: segments " R_{ISO} " and " $M\Omega$ " blink

PE Signal Lamp

Indicates whether or not voltage is present at the mains protective conductor.

Error Lamp

The red error lamp indicates that limit values have been exceeded during the measurement of protective conductor or insulation resistance, equivalent leakage, contact or leakage current, as well as residual current.

Piezoelectric Resonator

In the event that the error lamp lights up and the respectively more critical limit value is exceeded, the piezoelectric resonator also sounds.

Power Supply

Mains Voltage	230 V/50 Hz
Throughput	max. 3700 VA, dependent upon load at mains outlet

Electrical Safety

Protection Class	II
Nom. Mains Voltage	230 V
Test Voltage	Mains + PE (mains) + 2 mA socket for testing for the absence of voltage at test socket, connector jacks for phase and protective conductors and gripper clip: 3 kV~ mains to PE (mains) + 2 mA socket: 1.5 kV~
Measurement Category	II
Pollution degree	2
Safety Cut-Off	when device overheats

Electromagnetic Compatibility EMV

Product standards	EN 61326-1:2006 class B EN 61326-1:2006
-------------------	--

Ambient Conditions

Operation	- 10 ... + 55 °C
Storage	- 25 ... + 70 °C
Atmosph. Humidity	max. 75%
Elevation	to 2000 m

Mechanical Design

Dimensions	W x H x D: 190 mm x 140 mm x 95 mm
Weight	1.3 kg
Protection	Housing IP 40, terminals IP 20 Extract from table on the meaning of IP codes

IP XY (1 st digit X)	Protection against foreign object entry	IP XY (2 nd digit Y)	Protection against the penetration of water
0	not protected	0	not protected
1	≥ 50.0 mm Ø	1	vertically falling drops
2	≥ 12.5 mm Ø	2	vertically falling drops with enclosure tilted 15°
3	≥ 2.5 mm Ø	3	spraying water
4	≥ 1.0 mm Ø	4	splashing water

8 Maintenance – Calibration

Maintenance Housing

No special maintenance is required. Keep outside surfaces clean and dry. Use a slightly dampened cloth for cleaning. Avoid the use of solvents, cleansers or abrasives.

Recalibration

The respective measuring task and the stress to which your measuring instrument is subjected affect the aging of the components and may result in deviations from the guaranteed accuracy.

If high measuring accuracy is required and the instrument is frequently used in field applications, combined with transport stress and great temperature fluctuations, we recommend a relatively short calibration interval of 1 year. If your measuring instrument is mainly used in the laboratory and indoors without being exposed to any major climatic or mechanical stress, a calibration interval of 2-3 years is usually sufficient.

During recalibration* in an accredited calibration laboratory (DIN EN ISO/IEC 17025) the deviations of your instrument in relation to traceable standards are measured and documented. The deviations determined in the process are used for correction of the readings during subsequent application.

We are pleased to perform DAkkS or factory calibrations for you in our calibration laboratory. Please visit our website at www.gossenmetrawatt.com (→ Company → DAkkS Calibration Center *or* → FAQs → Calibration questions and answers).

By having your measuring instrument calibrated regularly, you fulfill the requirements of a quality management system per DIN EN ISO 9001. Standards DIN VDE 0701-0702 and IEC 63353 (VDE 0751) stipulate that only measuring instruments which are regularly tested and calibrated may be used for testing.

Device Return and Environmentally Compatible Disposal

The **instrument** is a category 9 product (monitoring and control instrument) in accordance with ElektroG (German Electrical and Electronic Device Law). This device is subject to the WEEE directive. Furthermore, we make reference to the fact that the current status in this regard can be accessed on the Internet at www.gossenmetrawatt.com by entering the search term WEEE.

We identify our electrical and electronic devices in accordance with WEEE 2012/19/EU and ElektroG with the symbol shown to the right per DIN EN 50419.

These devices may not be disposed of with the trash. Please contact our service department regarding the return of old devices.



* Verification of specifications or adjustment services are not part of the calibration. For products from our factory, however, any necessary adjustment is frequently performed and the observance of the relevant specification is confirmed.

9 Repair and Replacement Parts Service Calibration Center* and Rental Instrument Service

If required please contact:

GMC-I Service GmbH
Service-Center
Beuthener Straße 41
90471 Nürnberg, Germany
Phone +49 911 817718-0
Fax +49 911 817718-253
E-Mail service@gossenmetrawatt.com
www.gmci-service.com

This address is only valid in Germany.

Please contact our representatives or subsidiaries for service in other countries.

* DAkkS Calibration Laboratory for Electrical Quantities D-K-15080-01-01 accredited per DIN EN ISO/IEC 17025

Accredited measuring quantities: Direct voltage, direct current intensity, direct current resistance, alternating voltage, alternating current intensity, alternating current active power, alternating current apparent power, direct current power, capacity, frequency and temperature

Competent Partner

Gossen Metrawatt GmbH is certified in accordance with DIN EN ISO 9001.

Our DAkkS calibration laboratory is accredited by the Deutsche Akkreditierungsstelle GmbH (National accreditation body for the Republic of Germany) in accordance with DIN EN ISO/IEC 17025 under registration number D-K-15080-01-01.

We offer a complete range of expertise in the field of metrology: from **test reports** and **proprietary calibration certificates** right on up to **DAkkS calibration certificates**.

Our spectrum of offerings is rounded out with free **test equipment management**.

An on-site **DAkkS calibration station** is an integral part of our service department. If errors are discovered during calibration, our specialized personnel are capable of completing repairs using original replacement parts.

As a full service calibration laboratory, we can calibrate instruments from other manufacturers as well.

10 Product Support

If required please contact:

Gossen Metrawatt GmbH

Product Support Hotline

Phone +49 911 8602-0

Fax +49 911 8602-709

E-Mail support@gossenmetrawatt.com

© Gossen Metrawatt GmbH

Edited in Germany • Subject to change without notice / Errors excepted • A pdf version is available on the Internet

All trademarks, registered trademarks, logos, product names and company names are the property of their respective owners.

 **GOSSEN METRAWATT**

Gossen Metrawatt GmbH
Südwestpark 15
90449 Nürnberg • Germany

Phone +49 911 8602-111
Fax +49 911 8602-777
E-Mail info@gossenmetrawatt.com
www.gossenmetrawatt.com