

# CONDENSED OPERATING INSTRUCTIONS

1/5.24

3-447-225-03



## METRALINE MF

INSTALLATION TESTER FOR TESTING  
THE EFFECTIVENESS OF PROTECTIVE  
MEASUREMENTS IN ELECTRICAL  
INSTALLATIONS IN ACCORDANCE WITH  
IEC 60364-6, EN 61557 AND EN 50110-1  
(DIN VDE 0100-600, DIN VDE 0105-100,  
VDE 0413)

Read the complete operating instructions (available at [www.gossenmetrawatt.com](http://www.gossenmetrawatt.com)).

The condensed operating instructions do not replace the complete operating instructions!

---

# TABLE OF CONTENTS

---

<b>1</b>	<b>Safety Instructions</b> .....	<b>4</b>
<b>2</b>	<b>Applications</b> .....	<b>6</b>
2.1	Intended Use / Use for Intended Purpose .....	6
2.2	Use for Other than Intended Purpose .....	6
2.3	Repairs and Modifications .....	6
2.4	Liability and Guarantee .....	6
<b>3</b>	<b>Documentation</b> .....	<b>6</b>
3.1	Information Concerning these Instructions .....	6
3.2	Identification of Warnings .....	7
3.3	Identifiers .....	7
3.4	Symbols in the Documentation .....	8
<b>4</b>	<b>Getting Started</b> .....	<b>8</b>
<b>5</b>	<b>The Tester</b> .....	<b>9</b>
5.1	Scope of Delivery .....	9
5.2	Device Overview .....	9
5.3	Relevant Standards .....	11
5.4	Technical Data .....	12
5.5	Characteristic Values .....	13
<b>6</b>	<b>Menu and Functions</b> .....	<b>14</b>
6.1	Function Keys .....	14
6.2	User Interface .....	15
6.3	Voltage and Output Terminal Monitor .....	15
6.4	Battery Status Indication .....	16
6.5	Status Field .....	16
6.6	Acoustic Warnings .....	17
6.7	Measurement Functions .....	17
6.8	Measurement Settings .....	17
6.9	Setup Menu .....	18
6.10	Help Screen .....	19
<b>7</b>	<b>Configuration / Operation</b> .....	<b>20</b>
7.1	Unpacking the Instrument .....	20
7.2	Establishing Power Supply .....	20
7.3	Switching on/off .....	20
7.4	Selecting a Function or Subfunction .....	20
7.5	Performing a Measurement .....	20
7.6	Storing Measurements .....	21
7.7	Saving Measurements to PC .....	21

---

<b>8</b>	<b>Measuring / Testing</b> .....	<b>22</b>
8.1	Insulation Resistance Measurement .....	22
8.2	Continuity Measurement .....	22
8.3	Testing RCD .....	23
8.4	Fault Loop Impedance and Prospective Fault Current Measurement .....	24
8.5	Line Impedance and Prospective Short-Circuit Current Measurement .....	26
8.6	Phase Sequence Testing .....	27
8.7	Voltage and Frequency Measurement .....	27
8.8	Earth Resistance Measurement .....	28
<b>9</b>	<b>Contact, Support and Service</b> .....	<b>29</b>
<b>10</b>	<b>Certifications</b> .....	<b>30</b>
10.1	CE Declaration .....	30
10.2	Calibration Certificate .....	30
10.3	Test Report .....	30
<b>11</b>	<b>Disposal and Environmental Protection</b> .....	<b>30</b>



Read and follow these instructions carefully and completely in order to ensure safe and proper use.

The instructions must be made available to all persons who use the instrument.

Keep for future reference.

## General

- The device may only be used in the commercial field by qualified electricians.
- Observe the five safety rules in accordance with EN 50110-1 (DIN VDE 0105-100), Operation of electrical installations– Part 100: General requirements.  
(1: Shut down entirely. 2: Secure against restart. 3: Assure absence of voltage at all poles. 4: Ground and short circuit. 5: Cover neighboring live components, or make them inaccessible.
- Observe and comply with all safety regulations which are applicable for your work environment.
- Wear suitable and appropriate personal protective equipment (PPE) whenever working with the instrument.
- The functioning of active medical devices (for example pacemakers, defibrillators) and passive medical devices may be affected by voltages, currents and electromagnetic fields generated by the tester and the health of their users may be impaired. Implement corresponding protective measures in consultation with the manufacturer of the medical device and your physician. If any potential risk cannot be ruled out, do not use the instrument.

## Accessories

- Use only the specified accessories (included in the scope of delivery or listed as options) with the instrument.
- Carefully and completely read and adhere to the product documentation for optional accessories. Retain these documents for future reference.

## Handling

- Use the instrument in undamaged condition only.  
Inspect the instrument before use. Pay particular attention to damage, interrupted insulation or kinked cables.  
Damaged components must be replaced immediately.
- Use the accessories and all cables in undamaged condition only.  
Inspect accessories and all cables before use. Pay particular attention to damage, interrupted insulation or kinked cables.
- If the instrument or its accessories don't function flawlessly, permanently remove the instrument/accessories from operation and secure them against inadvertent use.
- If the instrument or accessories are damaged during use, for example if they're dropped, permanently remove the instrument/accessories from operation and secure them against inadvertent use.
- If there are any signs of interior damage to the instrument or accessories (e.g. Loose parts in the housing), permanently remove the instrument/accessories from operation and secure them against inadvertent use.
- The instrument and the accessories may only be used for the tests/measurements described in the documentation for the instrument.
- The integrated voltage measuring function and mains check of the test/measuring instrument may not be used to test systems or system components for the absence of voltage.  
Testing for the absence of voltage is only permissible with a suitable (2-pole) voltage tester / voltage measuring system which fulfills the requirements specified in DIN EN 61243.
- Route cables in an orderly fashion, e.g. the mains power cable and accessories cable. Loose, disorderly cables result in unnecessary danger of tripping and falling.

## Operating Conditions

- Do not use the instrument and its accessories after long periods of storage under unfavorable conditions (e.g. humidity, dust or extreme temperature).
- Do not use the instrument and its accessories after extraordinary stressing due to transport.

- 
- Do not expose the instrument to direct sunlight.
  - Only use the instrument and its accessories within the limits of the specified technical data and conditions (ambient conditions, IP protection code, measuring category etc.).
  - Do not use the instrument in potentially explosive atmospheres. Danger of explosion!
  - Do not use the instrument in atmospheres subject to fire hazard. Danger of fire
  - Implement adequate measures for protection against electrostatic discharge (ESD).

### **Rechargeable or Regular Batteries**

- Use batteries in undamaged condition only. Risk of explosion and fire in the case of damaged batteries! Inspect the batteries before use. Pay particular attention to leaky and damaged batteries.
- If you use batteries or rechargeable batteries, you may use the respective test and measuring instrument only with the battery compartment cover properly inserted and closed. Otherwise, dangerous voltages may occur at the (rechargeable) battery terminals under certain circumstances.
- Do not use the device while the internal batteries are being charged.
- Recharge batteries in undamaged condition only. Risk of explosion and fire in the case of damaged rechargeable batteries!  
Inspect the batteries before use. Pay particular attention to leaky and damaged batteries.

### **Fuses**

- The instrument may only be used as long as the fuses are in flawless condition. Defective fuses must be replaced. Fuses may only be replaced by our repair service department.
- Never bridge the fuses. Never put the fuses out of operation.

### **Measurement Cables and Establishing Contact**

- Plugging in the measurement cables must not necessitate any undue force.
- Never touch conductive ends (for example of test probes).
- Fully unroll all measurement cables before starting a test/measurement. Never perform a test/measurement with the measurement cable rolled up.
- Avoid short circuits due to incorrectly connected measurement cables.
- Ensure that alligator clips, test probes or Kelvin probes make good contact.
- Do not move or remove as far as possible plugs, test probes, alligator clips or Kelvin probes until testing/measurement has been completed.  
Unwanted sparking may otherwise occur due to test current.
- Only use measurement cables and external cabling with a maximum length of 1 m.

### **Adjustment /Calibration**

- Comply with national recalibration regulations and laws.
- Comply with national calibration regulations and laws.

### **Emissions**

- Switch off nearby cell phones while performing tests/measurements with the instrument. Cell phone signals may impair the correct functioning of the device due to interference.

### **Data Security**

- Always create a backup copy of your measurement/test data.
- The device is equipped with a data memory to which personal and/or sensitive data can be stored. Observe and comply with the applicable national data protection regulations. Use the corresponding functions provided by the test instrument (such as access protection), as well as other appropriate measures to prevent unauthorized access to the data.
- Protect the device against unauthorized tampering. Use the functions provided by the instrument (e.g. key lock/sealing/lock function) as well as other appropriate measures (e.g. restricting physical access to the instrument).

---

## 2 APPLICATIONS

---

Please read this important information!

### 2.1 INTENDED USE / USE FOR INTENDED PURPOSE

METRALINE MF is a professional, multifunctional, hand-held test instrument intended to perform all the measurements required for verification of electrical safety of installations in buildings. It is designed to perform the following measurement types:

- Loop resistance L-PE with short-circuit current calculation
- Loop resistance L-N
- Low resistance
- Continuity
- Insulation
- Testing of RCD for types A, AC, B, B+, F as well as 6 mA DC (RDC-DD) for E-charging stations
- Voltage (TRMS)
- Rotating field and frequency
- Earth resistance
- EVSE measurements

Safety of the user, as well as that of the instrument, is only assured when it's used for its intended purpose.

### 2.2 USE FOR OTHER THAN INTENDED PURPOSE

Using the instrument for any purposes other than those described in the operating instructions or these condensed operating instructions of the instrument is contrary to use for intended purpose. Use for Other than Intended Purpose may lead to unpredictable damage!

### 2.3 REPAIRS AND MODIFICATIONS

Unauthorized modification of the product is prohibited. Only authorized, trained personnel is permitted to perform repairs.

### 2.4 LIABILITY AND GUARANTEE

Liability and guarantee granted by Gossen Metrawatt GmbH complies with the applicable contractual and mandatory legal regulations.

---

## 3 DOCUMENTATION

---

### 3.1 INFORMATION CONCERNING THESE INSTRUCTIONS

The condensed operating instructions do not replace the complete operating instructions!

Read the complete operating instructions (available at [www.gossenmetrawatt.com](http://www.gossenmetrawatt.com)).

Read these instructions attentively and carefully. They contain all necessary information for safe use of the instrument. Comply with them in order to protect yourself and others from injury, and to avoid damaging the instrument.

The latest version of these instructions is available on our website:

<https://www.gmc-instruments.de/en/services/download-center/>



## Trademark Law

Product designations used in this document may be subject to brand law and patent law. They are of the property of their respective owner.

## Copyright

This document is protected by copyright. Content modifications, reproduction, duplication, processing or translation in any form (including excerpts) are only permissible after previously obtaining written consent from Gosson Metrawatt GmbH. This applies in particular to storage and processing in electronic systems provided they do not exclusively serve legitimate internal purposes.

### 3.2 IDENTIFICATION OF WARNINGS

Instructions for your safety and for the protection of the instrument and its environment are provided as warnings and notes at certain points within these instructions.

They're laid out as shown below and are graded in terms of the severity of the respective hazard. They also describe the nature and cause of the hazard, the consequences of non-observance and what must be done to avoid it.



#### DANGER

Death or serious injury is almost certain.



#### WARNING

Death or serious injury is possible.



#### CAUTION

Minor or moderate injury possible.

#### ATTENTION

Damage to the product or the environment



#### Note

Important information.



#### Tip

Useful additional information or application tip.

### 3.3 IDENTIFIERS

The following identifiers are used in this documentation:



Identifier	Meaning
Control Element	Keys, buttons, menus and other controls
✓ Prerequisite	A condition etc. which must be fulfilled before a given action can be taken
▶ Procedure	Beginning of a procedural instruction
1. Procedural step	Steps of a procedure which must be completed in the specified order

Identifier	Meaning
↳ Result	Result of a procedural step
■ Enumeration ■ Enumeration	Bullet lists
Abb. 2: Caption	Description of the content of a figure
Tab. 1: Table 1	Description of the content of a table
Footnote	Comment

Tab. 2: Identifiers in this document

### 3.4 SYMBOLS IN THE DOCUMENTATION

The following icons are used in this documentation:

Icon	Meaning
	Read and adhere to the product documentation.
	General warning symbol.
	Warning regarding electrical voltage.

Tab. 3: Icons used in this document

## 4 GETTING STARTED

This chapter gives you an overview of the initial steps with the instrument.

1. Read and adhere to the product documentation. In particular, observe all safety information in the documentation, on the tester and on the packaging.
  - Safety Instructions ⇨ 4
  - Applications ⇨ 6
  - Documentation ⇨ 6
2. Familiarize yourself with the tester.
  - The Tester ⇨ 9.
3. Familiarize yourself with the display and instrument operation.
  - Menu and Functions ⇨ 14
  - Configuration / Operation ⇨ 20
4. Perform measurements.
  - Measuring / Testing ⇨ 22



## 5 THE TESTER

### 5.1 SCOPE OF DELIVERY

Please check the scope of delivery for completeness and intactness.

- 1 METRALINE MF (M520F)
- 1 Carrying case
- 3 Test lead 1 m
- 1 Test cable with safety plug
- 3 Test probes
- 3 Crocodile clips
- 1 USB cable type A to type B
- 6 Rechargeable batteries 1.5 V
- 1 Power supply
- 1 Test lead with test button to trigger a measurement
- 1 Condensed operating instructions
- 1 Operating instructions (Download) <https://www.gmc-instruments.de/en/services/download-center/>
- 1 Software METRAreport (Download) <https://www.gossenmetrawatt.de/en/services/mygmc/>

### 5.2 DEVICE OVERVIEW

#### 5.2.1 FRONT



Abb. 5: Front Panel

- 1 TFT color display

## 5.2.2 BACK



Abb. 6: Back of Instrument

- 1 Battery compartment cover
- 2 Information label
- 3 Fixing screws for battery/fuse compartment cover

## 5.2.3 TOP



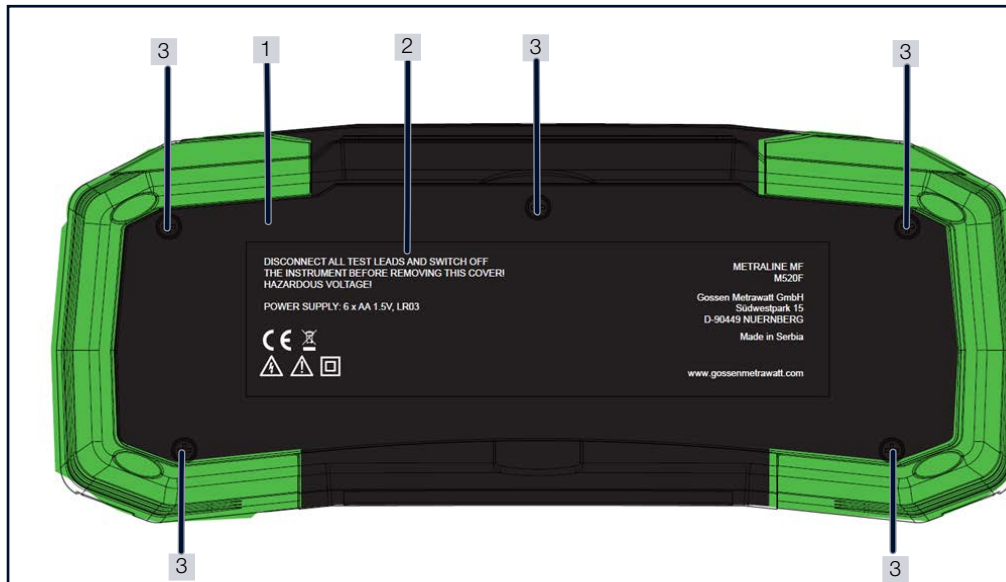



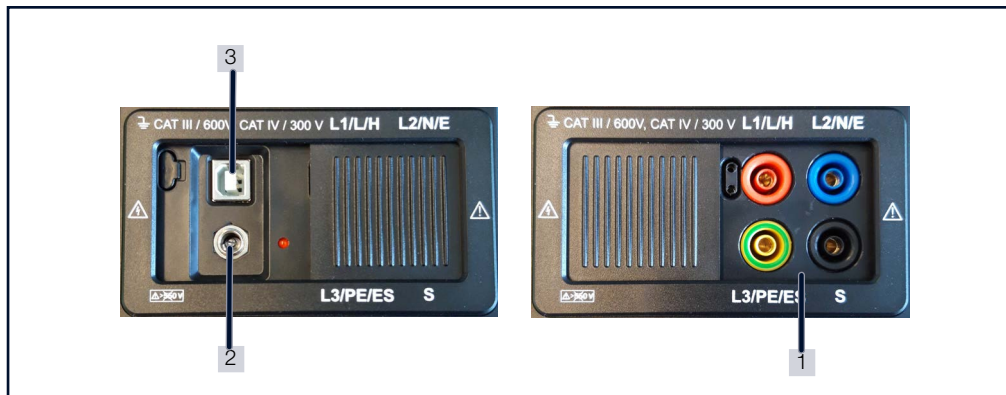

Abb. 7: Top of Instrument

- 1 Test lead sockets
- 2 Mains socket
- 3 USB port

## 5.2.4 SYMBOLS ON THE INSTRUMENT AND THE INCLUDED ACCESSORIES

Icon	Meaning	Icon	Meaning
	Warning concerning a point of danger (attention, observe documentation!)		Warning regarding electrical voltage
	Double insulation (protection category II)		The tester may not be disposed of with household trash ⇨ "Disposal and Environmental Protection" 30.
	European conformity marking		Power supply socket polarity

Tab. 4: Symbols on the Instrument and the Included Accessories

## 5.3 RELEVANT STANDARDS

The instrument has been manufactured and tested in accordance with the following safety regulations:

DIN EN 60529 IEC 60529	Test instruments and test procedures Degrees of protection provided by enclosures (IP code)
DIN EN 61010-1 IEC 61010-1	Safety requirements for electrical equipment for measurement, control and laboratory use – Part 1: General requirements
DIN EN 61010-031	Safety requirements for electrical equipment for measurement, control and laboratory use - Part 031: Safety requirements for hand-held and hand-manipulated probe assemblies for electrical test and measurement
DIN EN IEC 61326-1	Electrical equipment for measurement, control and laboratory use – EMC requirements – Part 1: General requirements
DIN EN IEC 61557-1	Electrical safety in low voltage distribution systems up to 1000 V <sub>AC</sub> and 1500 V <sub>DC</sub> – Equipment for testing, measuring or monitoring of protective measures – Part 1: General requirements
IEC 62955	Residual direct current detecting device (RDC-DD) to be used for mode 3 charging of electric vehicles

Tab. 5: Relevant Standards

## 5.4 TECHNICAL DATA

Power Supply		9 V <sub>DC</sub> (6 x 1.5 V Ni-MH batteries, size AA)
Ambient Conditions	Operating temperatures:	0 ... +40 °C
	Storage temperature:	-10 ... +70 °C
	Relative atmospheric humidity:	Max. 95%, no condensation allowed
	Elevation:	Max. 2000 m
Electrical Safety	Pollution degree:	2
	Protection category:	II
	Surge protection	600 V CAT III 300 V CAT IV
Electromagnetic Compatibility (EMC)	Interference emission:	EN 61326-1 class B
	Interference immunity:	DIN EN 61326-1 / IEC 61326-1 DIN EN 61326-2-33 / IEC 61326-2-33 EN 55011:2016 + A1:2017
Mechanical Design	Protection:	Housing: IP42 per DIN EN 60529 / IEC 60529 (protection against ingress of solid foreign objects: Ø ≥ 1.0 mm; protection against ingress of water: protected against dripping water when the housing is tilted up to 15°)
	Housing (W x H x D):	Approx. 25 x 10.7 x 13.5 cm
	Weight:	Approx. 1.30 kg (without batteries)
	Display:	480 x 320 TFT LCD
Data Interfaces	COM-port:	USB
Internal memory		1000 measurements

Tab. 6: Technical Data

## 5.5 CHARACTERISTIC VALUES











Function	Measured variable	Display range	
Continuity	Test current max. 7 mA	0.0 $\Omega$ ... 1999 $\Omega$	
	Test current min. 200 mA	0.00 $\Omega$ ... 1999 $\Omega$	
Insulation resistance ( $R_{ISO}$ )	Nominal voltages 50/100/250 V	0.000 M $\Omega$ ... 199.9 M $\Omega$	
	Nominal voltages 500/1000 V	0.000 M $\Omega$ ... 999 M $\Omega$	
RCD testing	Contact Voltage [ $U_c$ ]	0.0 V ... 99.9 V	
	Time [t]	0.0 ms ... 500.0 ms	
	Current [I]		$0.2 \times I_{\Delta N} \dots 1.1 \times I_{\Delta N}$ (AC)
			$0.2 \times I_{\Delta N} \dots 1.5 \times I_{\Delta N}$ (A).. ( $I_{\Delta N} \geq 30$ mA)
			$0.2 \times I_{\Delta N} \dots 2.2 \times I_{\Delta N}$ (A). ( $I_{\Delta N} < 30$ mA)
		$0.2 \times I_{\Delta N} \dots 2.2 \times I_{\Delta N}$ (B)	
Impedance	$Z_{line}$ L-L, L-N	0.0 $\Omega$ ... 9999 $\Omega$	
	$Z_{loop}$ L-PE	0.0 $\Omega$ ... 9999 $\Omega$	
	$Z_{loop}$ L-PE, non trip	0.0 $\Omega$ ... 9999 $\Omega$	
Voltage and frequency (V)	TRMS	0 V ... 550 V	
	Frequency	10.0 Hz ... 499.9 Hz	
Phase rotation	TRMS	50 V AC ... 550 V AC	
		45 Hz ... 400 Hz	
Earth resistance ( $R_E$ )	3-wire, 4-wire	0.00 $\Omega$ ... 9999 $\Omega$	
	Specific earth resistance	0.0 $\Omega$ ... 9999 $\Omega$	

Tab. 7: Characteristic Values

## 6 MENU AND FUNCTIONS

The instrument is operated via function keys on the front panel.  
The settings and values are displayed on the display.

### 6.1 FUNCTION KEYS

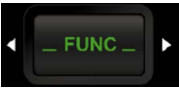
Key	Description	Function
	<b>save</b>	Saves a measurement or a setting
	<b>zero</b>	Compensates the test lead resistance in low-value resistance measurements
	<b>help</b>	Access the help menu
	<b>light</b>	Configure or turn off the display backlight
	<b>set</b>	Opens the setup menu
	<b>esc</b>	Exit a menu and return to the previous level
	<b>on/off</b>	Short keystroke: Instrument on Long keystroke: Instrument off The instrument will automatically switch off (APO) after the last key press if no voltage is applied
	<b>up</b>	Scroll upwards in a list
	<b>down</b>	Scroll downwards in a list
	<b>left</b>	Decrease a value Switch to the previous option
	<b>right</b>	Increase a value Switch to the next option
	<b>FUNC</b>	Switch between different measurement modes

Key	Description	Function
	START/enter	Start a test Enter a submenu Confirm an action

Tab. 8: Function Keys

## 6.2 USER INTERFACE



Abb. 8: Display

- |  |                 |
|--|-----------------|
| 1 Online voltage and output monitor        | 5 Status field  |
| 2 Options field                            | 6 Result field  |
| 3 Message field - battery status indicator | 7 Function line |
| 4 Current time                             |                 |

## 6.3 VOLTAGE AND OUTPUT TERMINAL MONITOR

Online voltages are displayed together with test terminal indication.

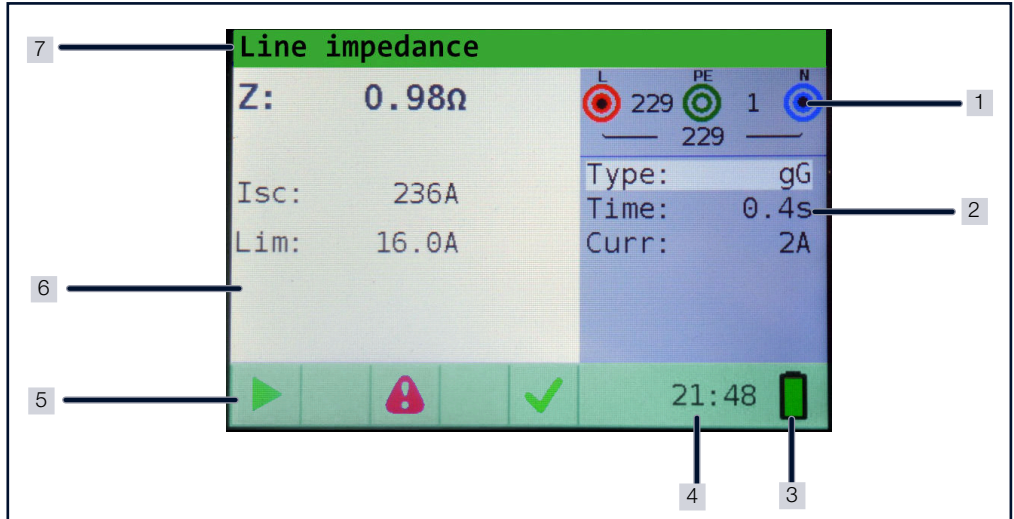
All three test terminals are used for selected measurement.

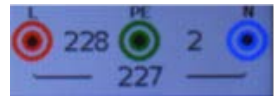



Online voltages are displayed together with test terminal indication.

L and N test terminals are used for selected measurement.















## 6.4 BATTERY STATUS INDICATION

Indicator	Description
	Battery power indication Here: Battery partially charged
	Battery low or empty Battery pack is too weak to guarantee correct result. Replace the batteries.

Tab. 9: Battery Status Indication

The recharge process is indicated by a LED near the power supply socket.

## 6.5 STATUS FIELD

Icon	Description	Icon	Description
	Dangerous voltage		RCD open or tripped
<b>COMP</b>	Test leads are compensated		RCD closed
	Not ready for measurement		Ready for measurement
	Dangerous voltage on PE		Temperature too high
	Result ok		Swap test leads
	Result not ok		Wait
	Noise on signal	<b>REF</b>	Reference measurement (optional)
	Check fuses	<b>SF</b>	Single fault in IT system (optional)

Tab. 10: Status Field Icons



## 6.6 ACOUSTIC WARNINGS

Sound	Description
Short high sound	Button is pressed
Continuous sound	During continuity test: The result is $< 35 \Omega$
Increasing alarm	Dangerous voltage is applied
Short sound	Power off, end of measurement
Decreasing alarm	Warnings: <ul style="list-style-type: none"><li>■ Temperature</li><li>■ Voltage and input</li><li>■ Start not possible</li></ul>
Periodic alarm	Warning! Phase voltage on the PE terminal! Stop all the measurements immediately and eliminate the fault before proceeding with any activity!

Tab. 11: Acoustic Warnings

## 6.7 MEASUREMENT FUNCTIONS

The following measurements can be selected by pressing **FUNC**:

- Voltage/rotation/frequency measurement
- Earth resistance (Ro, Re)
- Continuity (Continuity, R Low)
- R Insulation
- Line impedance (Line, voltage drop)
- Loop impedance (Loop, Rs, RCD)
- RCD (Auto, UC, Time, Current)
- EVSE measurement

## 6.8 MEASUREMENT SETTINGS

Parameters	Description
Mode	Sets the measurement mode
Limit	Sets the limit value
Distance	Earth resistance Ro: Sets the distance "a" between test rods
Type	Selects the RCD type
Time	Time
Curr	Current
F Isc	Scaling factor
IΔn	Sets the nominal current
Factor	Sets the nominal differential trip-out current multiplier
Pol.	Sets the test current starting polarity
Volt.	Sets the nominal test voltage
Freq	Frequency
Rotation	Rotation

Tab. 12: Measurement Settings

## 6.9 SETUP MENU

Submenu		Description
Date/time	Year Month Day Hour Minute	Sets date and time
Isc factor		Sets prospective short/fault current scaling factor
Start function	Last function Earth resistance Re Continuity R insulation Line impedance Loop impedance RCD Voltage	Sets the start function
RCD standard	EN 61008/EN 61009 EN 60364-4-41 TN/IT BS 7671 AZ NZS 3017	Select national standard for RCD testing
ELV	50 V AC / 120V DC 25V AC / 60V DC	Select voltage for ELV warning
Power off time	no power off 30s 1min 5min 10min 30min 1h	Sets the time after which the device automatically turns off
Continuity timeout	no timeout 30s 1min 5min 10min 30min 1h	Select time-out when measurement should stop automatically
R insulation timeout	no timeout 30s 1min 5min 10min 30min 1h	Select time-out when measurement should stop automatically
Supply system	TN (TT) IT Reduced low voltage (2 x 55 V)	Select supply network/system

Submenu		Description
Device info		Displays information about the device: SN, Firmware, next calibration
Language	English German Dutch French Spanish Italian	Changes the language of the user interface
Buzzer	Alarm and errors Alarm only All sounds	Sets the options, when the buzzer should be active

Tab. 13: Setup Menu

- Press the key **set** to enter the setup menu.
- Press **up / down** to select the submenu.
- Press **START/enter** to enter the submenu.
- Press **left / right** to increase or decrease the value.

## 6.10 HELP SCREEN

The **help** screens contain diagrams that show the correct use of the device for every kind of measurement.



Abb. 9: Help Screen

- Press the key **help** to enter the help screen.
- Press **left** to switch to the previous help screen.
- Press **right** to switch to the next help screen.
- Press **help** or **esc** to close the help screen.

---

## 7 CONFIGURATION / OPERATION

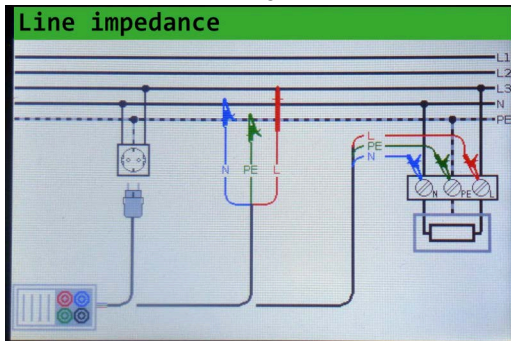
---

### 7.1 UNPACKING THE INSTRUMENT

1. Carefully remove instrument and accessories from the packaging.
2. Check delivery for completeness and possible damage.
3. In case of detected damages, hidden defects and short deliveries, document type and scope and contact the manufacturer or supplier immediately.
4. Keep packing material for further transport.

### 7.2 ESTABLISHING POWER SUPPLY

1. Remove the screws of the battery compartment cover on the back side of the instrument.
2. Remove the battery/fuse compartment cover.
3. Insert 6 1.5 V AA batteries into the battery tray. Ensure the correct polarity.
4. Place the battery compartment cover onto the battery tray.
5. Fix the screws of the battery compartment cover.

### 7.3 SWITCHING ON/OFF

#### 7.3.1 SWITCHING ON THE INSTRUMENT

1. Briefly press the key **on/off**.
2. The firmware version is displayed on the screen for a few seconds. Afterwards, the last set mode is displayed on the screen. The instrument is ready for operation.

#### 7.3.2 SWITCHING OFF THE INSTRUMENT

1. Press the key **on/off** for a few seconds.
2. The instrument is switched off.

### 7.4 SELECTING A FUNCTION OR SUBFUNCTION

1. Press **up** or **down** to select the the parameter or limit value you want to edit.
  2. Press **left** or **right** to set the value for the selected parameter.
- ↳ The settings are retained until new changes are made.

### 7.5 PERFORMING A MEASUREMENT



#### Note

The indicator **Not ready for measurement** means that the selected measurement cannot be performed because of irregular conditions on input terminals.

Insulation resistance, continuity functions and earth resistance measurements can only be performed on de-energized objects.

**PASS / FAIL** indication is enabled when limit is set. Apply appropriate limit value for evaluation of measurement results.

In the case that only two of the three wires are connected to the electrical installation under test, only voltage indication between these two wires is valid.

1. Select the measurement function.
  2. According to the measurement function, select the measurement mode.
  3. According to the measurement function, select the limit values and/or parameters.
  4. Connect the test leads to the instrument as described in the measurement function's **help** diagram.
  5. Connect the test cables to the DUT as described in the measurement function's **help** diagram.
  6. Check the status field for warnings.
  - ✓ The symbol **Ready for measurement** is displayed in the status field.
  7. Press **START/enter**.
- ↳ The test is performed.  
The result value is displayed.

---

The result is marked with the symbol for the test status:

**Result ok** = Test passed

**Result not ok** = Test not passed.

## 7.6 STORING MEASUREMENTS

After the measurement is completed, results can be stored in internal memory of the instrument together with the sub-results and function parameters.

- Store up to 1000 measurements
- Step through the list of records
- Delete a single record or all records
- Edit the IDs for customer, location and object

## 7.7 SAVING MEASUREMENTS TO PC

With the **METRAreport** software, you can manage the measurements.

- Export csv files
- Generate Microsoft Excel files
- Generate certificates

The **METRAreport** software is available via the website <https://www.gmc-instruments.de/services/mygmc>.

## 8 MEASURING / TESTING

### 8.1 INSULATION RESISTANCE MEASUREMENT

The insulation resistance measurement is performed to ensure safety against electric shock. Using this measurement, the following items can be determined:

- Insulation resistance between installation conductors
- Insulation resistance of non-conductive rooms (walls and floors)
- Insulation resistance of ground cables
- Resistance of semi-conductive (antistatic) floors

### 8.2 CONTINUITY MEASUREMENT

Two continuity sub-functions are available:

- R Low (ca. 240 mA) continuity test with automatic polarity reversal
- Low current (ca. 4 mA) continuous continuity test (optional), useful when testing inductive systems

#### 8.2.1 R LOW TEST



Abb. 8: R Low Test, Wiring and Results

This function is used to test the resistance between two different points of the installation to ensure that a conductive path exists between them. The test ensures that all protective conductors, earth conductors or bonding conductors are correctly connected, terminated and have the correct resistive value.

The measurement of the R Low resistance is performed with a test current of more than 200 mA. An automatic pole reversal of the test voltage and the test current is performed during the test. This test checks for any components (e.g. diodes, transistors, SCRs) that may have a rectifying effect on the circuit which could cause problems when a voltage is applied.

#### 8.2.2 CONTINUITY TEST

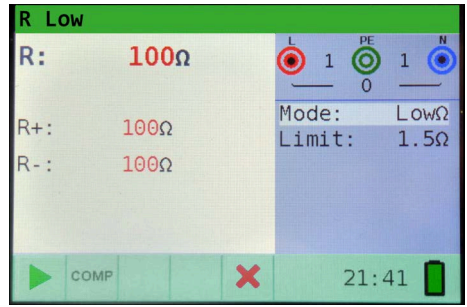
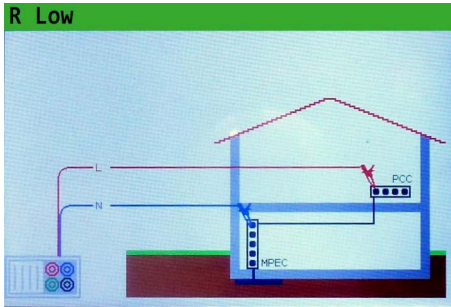

Abb. 9: Continuity Test, Wiring and Results

Continuous low-value resistance measurements can be performed without pole reversal of the test voltages and a lower test current (a few mA). In general, the function serves as an ordinary  $\Omega$ -meter with low-test current. The function can also be used to test inductive components such as motors and coiled cables.

### 8.3 TESTING RCD

RCD testing has four sub-functions:

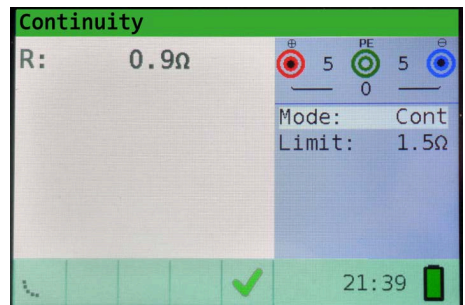
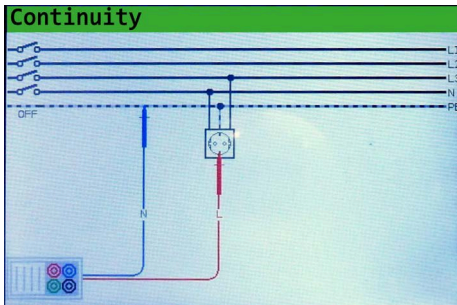
- Contact voltage measurement
- Trip-out time measurement
- Trip-out current measurement
- RCD autotest

#### 8.3.1 CONTACT VOLTAGE



Abb. 10: Contact Voltage Measurement, Wiring and Results

Leakage current flowing to the PE terminal causes a voltage drop across earth resistance, which is called contact voltage ( $U_c$ ). This voltage is present on all accessible parts connected to the PE terminal and should be lower than the safety limit voltage.

The parameter contact voltage is measured without tripping-out the RCD.

#### 8.3.2 TRIP-OUT TIME

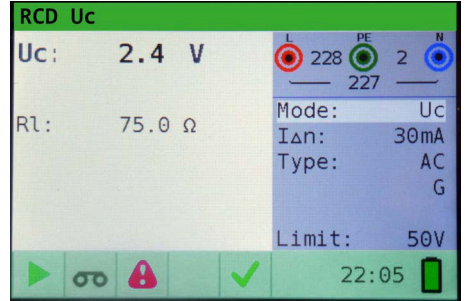
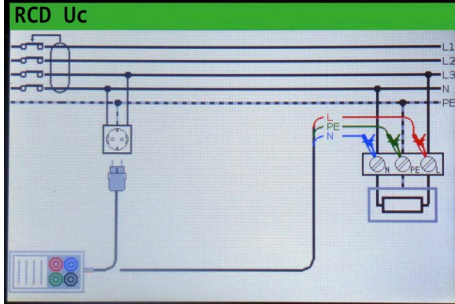

Abb. 11: Trip-out Time Measurement, Wiring and Results

Trip-out time measurement is used to verify the effectiveness of an RCD. This is achieved by a test simulating an appropriate fault condition.

### 8.3.3 TRIP-OUT CURRENT

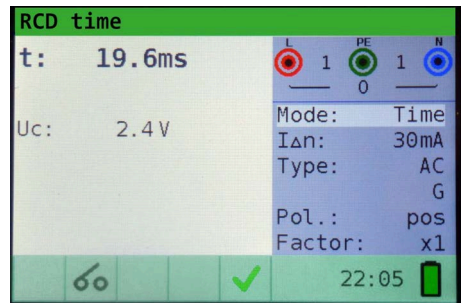
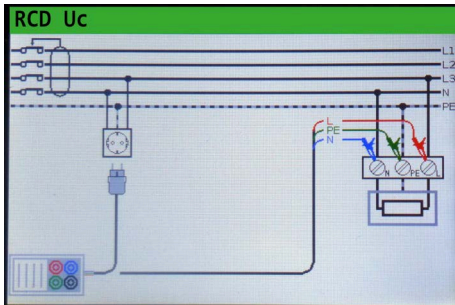

Abb. 12: Trip-out Current Measurement, Wiring and Results

This test is used to determine the minimum current required to trip the RCD. After the measurement has been started, the test current generated by the instrument is continuously increased, starting at  $0.2 I_{\Delta N}$  to  $1.1 I_{\Delta N}$  (to  $1.5 I_{\Delta N} / 2.2 I_{\Delta N}$ ,  $I_{\Delta N} = 10 \text{ mA}$ , for pulsating DC residual currents), until the RCD trips.

### 8.3.4 RCD AUTOTEST

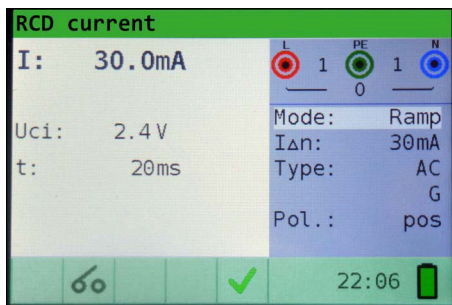
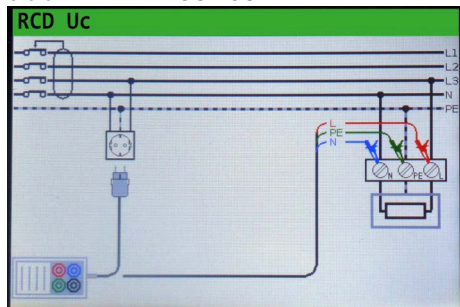

Abb. 13: RCD Autotest, Wiring and Results

The purpose of the autotest function is to perform a complete RCD testing and measurement of most important associated parameters (contact voltage, fault loop resistance and trip-out time at different fault currents) with one press of a button. If a faulty parameter is noticed during the autotest, the test will stop to highlight the need for further investigation.

## 8.4 FAULT LOOP IMPEDANCE AND PROSPECTIVE FAULT CURRENT MEASUREMENT

The loop impedance function has three sub-functions:

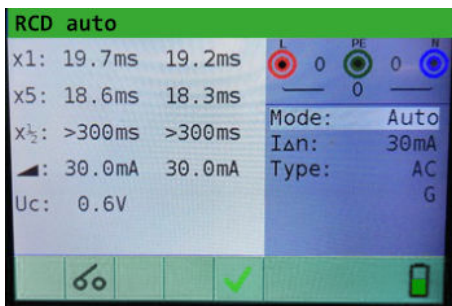
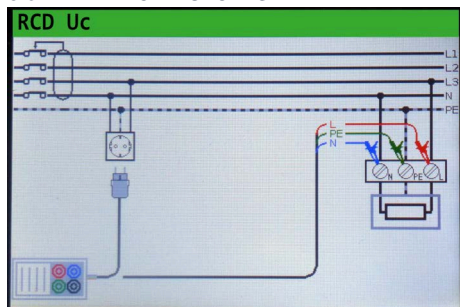
- LOOP IMPEDANCE sub-function performs a fast fault loop impedance measurement on supply systems which do not contain RCD protection.
- LOOP IMPEDANCE RCD trip-lock sub-function performs fault loop impedance measurement on supply systems which are protected by RCDs
- LOOP IMPEDANCE R<sub>s</sub> sub-function with configurable RCD-value performs fault loop impedance measurement on supply systems which are protected by RCDs



### 8.4.1 FAULT LOOP IMPEDANCE



Abb. 14: Fault Loop Impedance Test, Wiring and Results

The fault loop impedance measures the impedance of the fault loop in the event that a short-circuit to an exposed conductive part occurs (i.e. a conductive connection occurs between the phase conductor and protective earth conductor). To measure loop impedance, the instrument uses a high-test current.

### 8.4.2 FAULT LOOP IMPEDANCE TEST RCD (FOR RCD PROTECTED CIRCUITS)

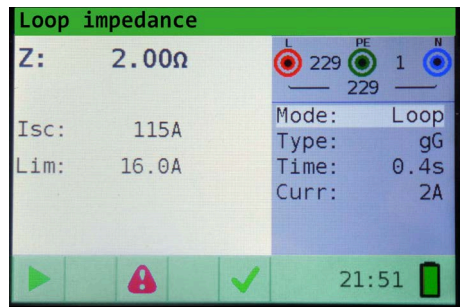
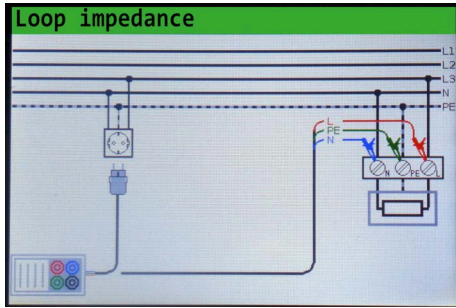

Abb. 15: Fault Loop Impedance RCD Test, Wiring and Results

The fault loop impedance is measured with a low test current to avoid tripping the RCD. This function can also be used for fault loop impedance measurement in system equipped with RCDs which have a rated trip-out current of 30 mA and above.

### 8.4.3 FAULT LOOP IMPEDANCE TEST RS (FOR ADJUSTABLE CURRENT)

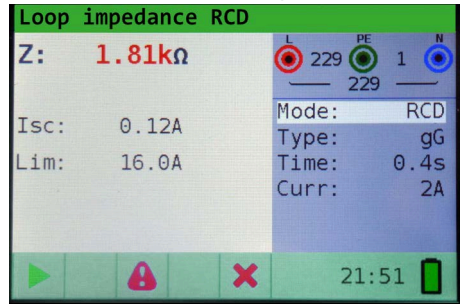
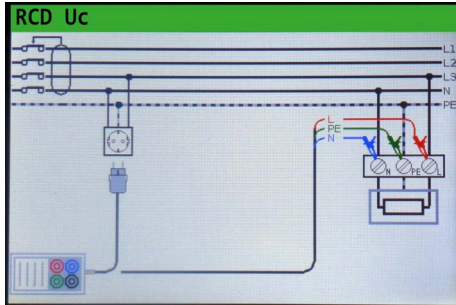

Abb. 16: Fault Loop Impedance Rs Test, Wiring and Results

The fault loop impedance is measured with a low test current to avoid tripping the RCD. It is possible to adjust the value of the RCD, while the test current depends on the chosen value. By this function it is possible to test each RCD-type with the maximum possible current without tripping the RCD.

## 8.5 LINE IMPEDANCE AND PROSPECTIVE SHORT-CIRCUIT CURRENT MEASUREMENT

The line impedance is a measurement of the impedance of the current loop when a short-circuit to the neutral conductor occurs (conductive connection between phase conductor and neutral conductor in single-phase system or between two phase conductors in three-phase system). A high test current is used to perform the line impedance measurement.

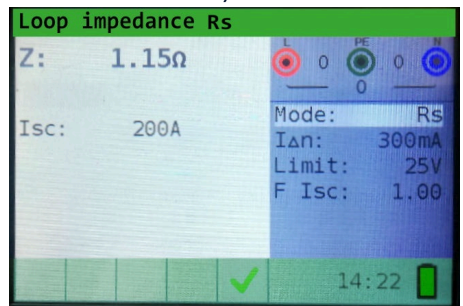
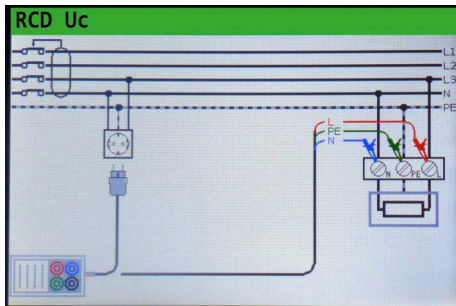
### 8.5.1 LINE IMPEDANCE MEASUREMENT



Abb. 17: Line Impedance Measurement, Wiring and Results

### 8.5.2 VOLTAGE DROP MEASUREMENT

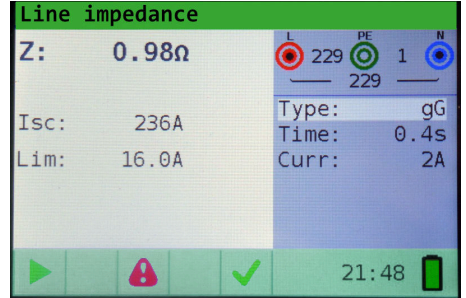
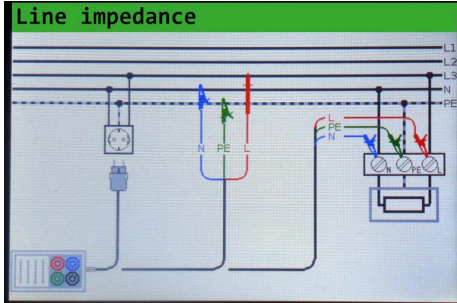

Abb. 18: Voltage Drop Measurement, Wiring and Results

The voltage drop function is a measurement of the line impedance and result is compared to a reference result which has been taken before on some other point of the installation (usually the entry point since this point has the lowest impedance). The voltage drop in %, the impedance and the prospective short circuit current are shown.

## 8.6 PHASE SEQUENCE TESTING

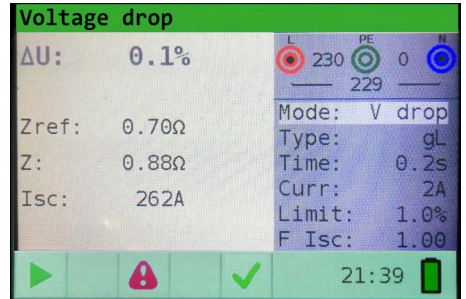
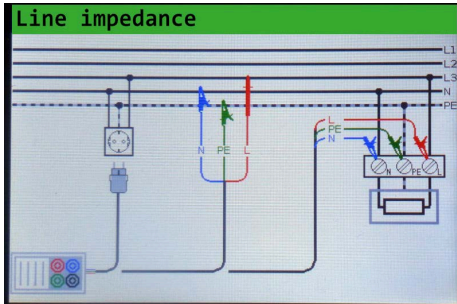

Abb. 19: Phase Sequence Test, Wiring and Results

In practice, we often deal with the connection of three-phase loads (motors and other electro-mechanical machines) to three-phase mains installation. Some loads (ventilators, conveyors, motors, electro-mechanical machines, etc.) require a specific phase rotation and some may even be damaged if the rotation is reversed. This is why it is advisable to test phase rotation before a connection is made.

## 8.7 VOLTAGE AND FREQUENCY MEASUREMENT

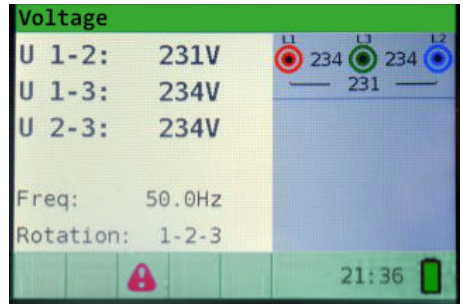
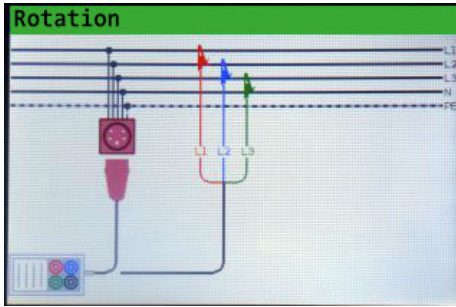

Abb. 20: Voltage and Frequency Measurement, Wiring and Results

Voltage measurements should be carried out regularly while dealing with electric installations (carrying out different measurements and tests, looking for fault locations, etc.). Frequency is measured for example when establishing the source of mains voltage (power transformer or individual generator).

## 8.8 EARTH RESISTANCE MEASUREMENT

### 8.8.1 EARTH RESISTANCE MEASUREMENT (RE), 3-WIRE, 4-WIRE

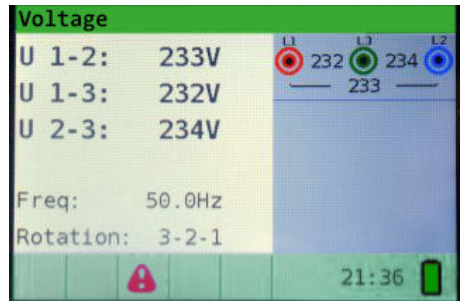
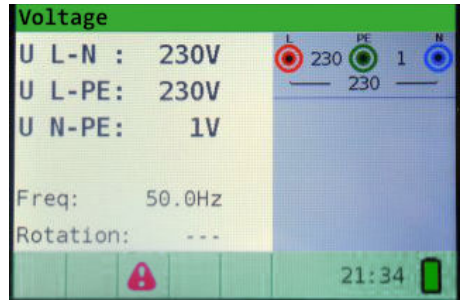
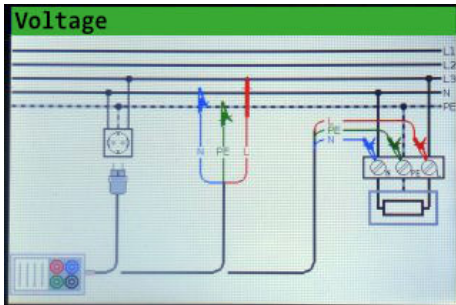

Abb. 21: Earth Resistance Measurement Re, Wiring and Results

### 8.8.2 SPECIFIC EARTH RESISTANCE MEASUREMENT (RO)

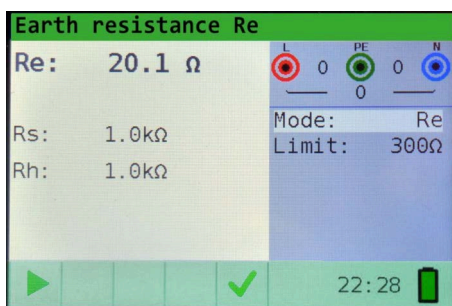
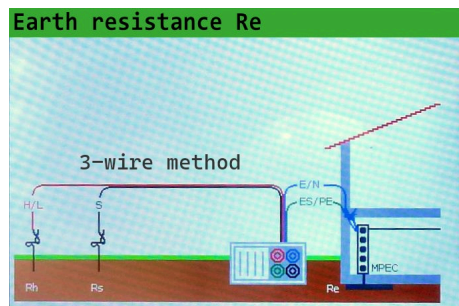
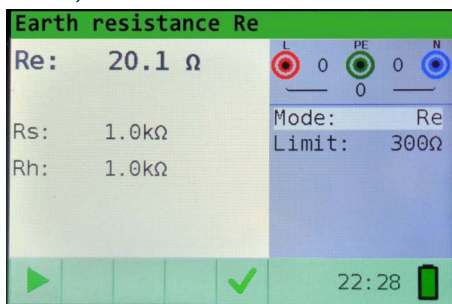
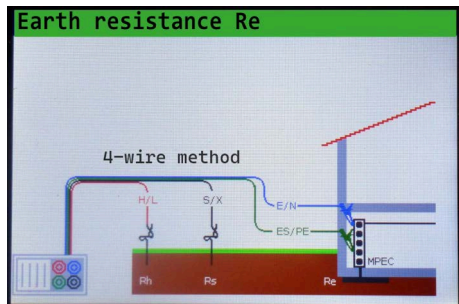

Abb. 22: Earth Resistance Measurement Ro, Wiring and Results

It is advisable to measure Earth Resistivity, when defining parameters of earthing system (required length and surface of earth electrodes, most appropriate depth of installing earthing system etc.) to reach more accurate calculations.

---

## 9 CONTACT, SUPPORT AND SERVICE

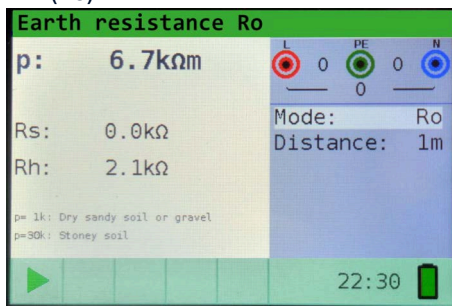
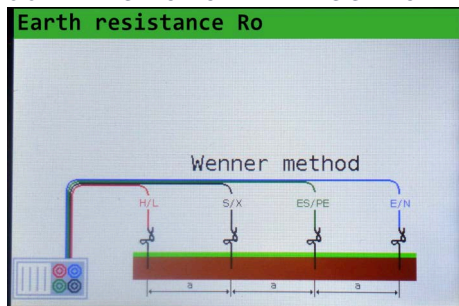
---

Gossen Metrawatt GmbH can be reached directly and simply – we have a single number for everything! Whether you require support or training, or have an individual inquiry, we can answer all of your questions here:

+49-911-8602-0

Monday to Thursday:

8 a.m. to 4 p.m.

Friday:

8 a.m. to 2 p.m.

Or contact us by e-mail at:

info@gossenmetrawatt.com

Do you prefer support by e-mail?

**Measuring and Test Technology:**

support@gossenmetrawatt.com

**Industrial Measuring Technology:**

support.industrie@gossenmetrawatt.com

Please contact GMC-I Service GmbH for repairs, replacement parts and calibration<sup>1</sup>:

+49-911-817718-0

service@gossenmetrawatt.com

[www.gmci-service.com/en/](http://www.gmci-service.com/en/)

Beuthener Str. 41  
90471 Nürnberg  
Germany



---

1. DAkkS calibration laboratory per DIN EN ISO/IEC 17025  
accredited by the Deutsche Akkreditierungsstelle GmbH under reference number D-K-15080-01-01.

---

## 10 CERTIFICATIONS

---

### 10.1 CE DECLARATION

The instrument fulfills all requirements of applicable EU directives and national regulations. We confirm this with the CE mark.

You can find the CE declaration on our website:

<https://www.gmc-instruments.de/en/services/download-center/>



### 10.2 CALIBRATION CERTIFICATE

A calibration certificate is available on demand → "Contact, Support and Service" 29.

### 10.3 TEST REPORT

A test report is available at:

<https://www.gossenmetrawatt.de/en/services/mygmc/>

---

## 11 DISPOSAL AND ENVIRONMENTAL PROTECTION

---

Proper disposal makes an important contribution to the protection of our environment and the conservation of natural resources.

### ATTENTION

#### Environmental Damage

Improper disposal results in environmental damage.

- Follow the instructions concerning return and disposal included in this section.

The following comments refer specifically to the legal situation in the Federal Republic of Germany. Owners or end users who are subject to other regulations must comply with the respective local requirements and implement them correctly on site. Further information can be obtained, for example, from the responsible authorities or the local distributor.

#### Waste Electrical Equipment, Electrical or Electronic Accessories and Waste Batteries (including rechargeable batteries)

Electrical equipment and batteries (including rechargeable batteries) contain valuable raw materials that can be recycled, as well as hazardous substances which can cause serious harm to human health and the environment, and they must be recycled and disposed of correctly.



The symbol at the left depicting a crossed-out garbage can on wheels refers to the legal obligation of the owner or end user (German electrical and electronic equipment act ElektroG and German battery act BattG) not to dispose of used electrical equipment and batteries with unsorted municipal waste ("household trash"). Waste batteries must be removed from the old device (where possible) without destroying them and the old device and the waste batteries must be disposed of separately. The battery type and its chemical composition are indicated on the battery's labelling. If the abbreviations "Pb" for lead, "Cd" for cadmium or "Hg" for mercury are included, the battery exceeds the limit value for the respective metal.

Please observe the owner's or end user's responsibility with regard to deleting personal data, as well as any other sensitive data, from old devices before disposal.

---

Old devices, electrical or electronic accessories and waste batteries (including rechargeable batteries) used in Germany can be returned free of charge to Gossen Metrawatt GmbH or the service provider responsible for their disposal in compliance with applicable regulations, in particular laws concerning packaging and hazardous goods. Waste batteries must be handed over in discharged state and/or with appropriate precautionary measures against short-circuiting. Further information regarding returns can be found on our website.

### **Packaging Materials**

We recommend retaining the respective packaging materials for the case that you might require servicing or calibration in the future.



#### **WARNING**

#### **Danger of Asphyxiation Resulting from Foils and Other Packaging Materials**

Children and other vulnerable persons may suffocate if they wrap themselves in packaging materials, or their components or foils, or if they pull them over their heads or swallow them.

- Keep packaging materials, as well as their components and foils, out of the reach of babies, children and other vulnerable persons.

---

In accordance with German packaging law (VerpackG), the user is obligated to correctly dispose of packaging and its components separately, and not together with unsorted municipal waste ("household trash"). Private end consumers can dispose of packaging free of charge at the responsible collection point. Packaging which is not subject to so-called system participation is returned to the appointed service provider. Further information regarding returns can be found on our website.



© Gossen Metrawatt GmbH  
Prepared in Germany • Subject to change / errors excepted •  
A pdf version is available on the Internet

All trademarks, registered trademarks, logos, product names,  
and company names are the property of their respective  
owners.

## YOUR CONTACT

Gossen Metrawatt GmbH  
Südwestpark 15  
90449 Nürnberg  
Germany



+49 911 8602-0



+49 911 8602-669



[info@gossenmetrawatt.com](mailto:info@gossenmetrawatt.com)



[www.gossenmetrawatt.com](http://www.gossenmetrawatt.com)