

METRACELL BT PRO

Portable Battery Tester

3-447-058-03
1/4.20



Table of Contents

1	Safety Precautions	1	10	Performing Measurements	30
2	Important Information	2	10.1	General Information.....	30
2.1	Intended Use / Use for Intended Purpose.....	2	10.2	Multimeter Measurements.....	32
2.2	Use for Other than Intended Purpose.....	2	10.3	Charge Retention Measurement.....	33
2.3	Liability and Guarantee	2	10.4	Discharge Measurement	35
2.4	Opening the Instrument / Repairs	2	10.5	Charge Measurement	37
3	Documentation	2	10.6	Resistance Measurement.....	39
3.1	Identifiers	2	10.7	Temperature Measurement.....	41
3.2	Definition of Terms.....	2	10.8	Connector Measurement	43
4	Getting Started	3	10.9	Interval U Measurement	45
5	The Instrument	3	10.10	Interval U+I Measurement	47
5.1	Scope of Delivery.....	3	10.11	DMA35 Measurement (IrDA).....	49
5.2	Optional Accessories	3	10.12	DMA35 Measurement (BT).....	49
5.3	Instrument Overview	3	11	Viewing, Editing, Transferring and Evaluating Measured Values	50
5.4	Relevant Standards	4	11.1	Viewing Measured Values / Measured Value Details at the Instrument.....	50
5.5	Measurement Inputs.....	5	11.2	Viewing Measured Value Evaluations at the Instrument ..50	
5.6	LCD Display.....	5	11.3	Excluding a Measurement from Transmission (deactivate measurement).....	50
5.7	Function Keys / Navigation	5	11.4	Deleting Measured Values.....	50
5.8	RFID Reader.....	5	11.5	Saving Measured Values to a PC (data backup).....	50
5.9	Attachment Options.....	5	12	Maintenance	52
5.10	Technical Data.....	6	12.1	Firmware Update	52
5.11	Characteristic Values	6	12.2	Housing and Display	52
6	Operation	7	12.3	Measurement Cables	52
6.1	Power Supply (rechargeable batteries).....	7	12.4	Fuse.....	53
6.2	Switching the Instrument On/Off.....	7	12.5	Accessories	53
6.3	System Settings.....	8	13	Service and Support	53
6.4	Establishing and Terminating Wireless Connections.....	8	13.1	Product Support	53
6.5	Testing the RFID Reader.....	9	13.2	Repair and Replacement Parts Service Calibration Center * and Rental Instrument Service	53
7	Menu and Functions	10	14	CE Declaration	54
7.1	Overview.....	10	15	Returns and Environmentally Sound Disposal	54
7.2	Display Menu.....	12			
7.3	Measurement Menu.....	12			
7.4	Data Menu.....	15			
7.5	The SETTINGS Menu.....	16			
7.6	INFO Menu	17			
8	“BT PRO Manager” PC Software	18			
8.1	Installation, Launching the Program and Update.....	18			
8.2	Overview.....	18			
8.3	Defining the Data(base) Storage Location	18			
8.4	Managing User Accounts.....	19			
8.5	Basic Setting: Specifying the Temperature Unit of Measure	20			
8.6	Creating and Managing the Battery Database.....	20			
8.7	Transferring the Battery Database to the Battery Tester ..23				
8.8	Assigning RFID Tags to Batteries (DUTs).....	24			
8.9	Importing Measurement Data.....	24			
8.10	Viewing Measurement Series and Creating Measurement Evaluations (reports).....	25			
9	Preparing Measurements	28			
9.1	General Information (procedure).....	28			
9.2	Switching Polarity On or Off	28			
9.3	Connecting Measuring Accessories	28			

1 Safety Precautions

Observe this documentation, in particular all included safety information, in order to protect yourself and others from injury, and to prevent damage to the instrument.

- Carefully and completely read and adhere to these operating instructions, as well as the instrument's condensed operating instructions.
The respective documents can be found at <http://www.gossenmetrawatt.com>. Retain these documents for future reference.
- Use only the specified accessories with the instrument!
- Carefully and completely read and adhere to the product documentation for optional accessories. Retain these documents for future reference.
- Tests may only be performed by a qualified electrician, or under the supervision and direction of a qualified electrician. The user must be instructed by a qualified electrician concerning performance and evaluation of the tests.
- Wear suitable and appropriate personal protective equipment (PPE) whenever working with the instrument.
- Implement adequate measures for protection against electrostatic discharge (ESD).
- Observe and comply with all applicable DIN, VDE, EN, IEC and ANSI guidelines. Inform yourself concerning the operating company's specifications and guidelines, as well as those of the respective battery manufacturers.
- Batteries are electrochemical components with very high short-circuit currents. Avoid short-circuits which endanger yourself as a user, the entire system or operating personnel.
- If the instrument doesn't function flawlessly, remove it from operation and secure it against inadvertent use.
- The instrument may only be used as long as it's in good working order.
Inspect the housing before use. Pay particular attention to any possible cracks and the insulation around the sockets. Damaged components must be replaced immediately.
- Accessories and cables may only be used as long as they're fully intact.
Inspect all cables and accessories before use. Pay particular attention to damage, broken insulation or kinked cables. Damaged components must be replaced immediately.
- Do not use the instrument after long periods of storage under unfavorable conditions (e.g. humidity, dust or extreme temperature).
- Do not use the instrument after extraordinary stressing due to transport.
- Do not use the instrument in potentially explosive atmospheres.
- Use the instrument only within the specified ambient conditions.
- Use the instrument only in accordance with the specified protection class (IP code).
- The instrument must not be exposed to direct sunlight.
- The instrument and the included accessories may only be used for the measurements described in this manual.
- Only use accessories and the charger which are included with the battery tester or listed as optional accessories.
- Only use the instrument and the accessories within the specified measuring category.
- The measurement cables and all external cabling must not exceed an overall length of 1 meter.
- Plugging in the measurement cables and the power pack must not necessitate any undue force.
- Connect the ground wire before connecting the voltage conducting cable, and disconnect the voltage conducting cable before disconnecting the ground wire.
- Check measurement cable continuity.
- Avoid short circuits due to incorrectly connected measurement cables.
- Never touch the conductive ends of the alligator clips, the test probes or the Kelvin probes.
- Ensure that the alligator clips, test probes and Kelvin probes make good contact.
- Do not move or remove the Kelvin probes during a measurement. Unwanted sparking may otherwise occur due to test current.
- Do not remove or move the alligator clips, test probes or Kelvin probes until measurement has been completed. Completion of measurement is indicated by means of an acoustic acknowledgment.
- Avoid simultaneously contacting the battery and the frame or hardware, which may be grounded.
- The battery tester is equipped with a transponder module. Determine whether or not use of the 125 kHz frequency is permissible in your country.
- The battery tester is equipped with a Bluetooth® module. Determine whether or not use of the implemented frequency range of 2.402 to 2.480 GHz is permissible in your country.
- The input at the P+ measurement jack is equipped with a fuse link. The instrument may only be used as long as this fuse is in flawless condition.
A defective fuse may only be replaced by our repair service.
- The instrument only works with inserted batteries.
- The battery charger may only be connected to electrical systems (TN or TT) with a maximum of 230/400 V which comply with applicable safety regulations (e.g. IEC 60346, VDE 0100) and are protected with a fuse or circuit breaker with a maximum rating of 16 A.
- Do not use the instrument while the internal batteries are being charged.
- Do not use the instrument if the battery compartment cover has been removed.
- Always create a backup copy of your measurement data.

2 Important Information

Please read this important information!

2.1 Intended Use / Use for Intended Purpose

Periodic testing and well-organized maintenance are necessary in order to assure the availability of stationary battery systems.

The METRACELL BT PRO is a multifunctional instrument for testing batteries and battery blocks (referred to below as “devices under test” or “DUTs”). It can be used to determine the current status of a DUT and pinpoint concealed defects. The battery tester is used primarily for testing DUTs in stationary battery systems.

The battery tester stores measured values internally. All recorded measured values can be viewed on site. Individual acquired values can be conveniently re-measured if necessary. Management of devices under test, as well as evaluation and backup of the measured values, is handled by the included “BT PRO Manager” software. The measured values can also be transferred to an external computer as a CSV file.

The battery tester is a portable instrument which can be held in the hand while performing measurements.

Safety of the operator, as well as that of the instrument, is only assured when it’s used for its intended purpose.

2.2 Use for Other than Intended Purpose

Using the instrument for any purposes other than those described in the condensed operating instructions or these instrument operating instructions is contrary to use for intended purpose.

2.3 Liability and Guarantee

GMC-I Messtechnik GmbH assumes no liability for property damage, personal injury or consequential damage resulting from improper or incorrect use of the product, in particular due to failure to observe the product documentation. Furthermore, all guarantee claims are rendered null and void in such cases.

Nor does GMC-I Messtechnik GmbH assume any liability for data loss.

2.4 Opening the Instrument / Repairs

The instrument may only be opened by authorized, trained personnel in order to ensure flawless, safe operation and to assure that the guarantee isn’t rendered null and void. Even original replacement parts may only be installed by authorized, trained personnel.



Unauthorized modifications to the instrument are prohibited.

If it can be ascertained that the battery tester has been opened by unauthorized personnel, no guarantee claims can be honored by the manufacturer with regard to personal safety, measuring accuracy, compliance with applicable safety measures or any consequential damages.

3 Documentation

3.1 Identifiers

The following identifiers are used in this documentation:

Identifier	Meaning
 Attention! Warning	Safety information that must be complied with
 Note Important	Important information which must be taken into consideration and complied with
✓ Prerequisite	A condition etc. which must be fulfilled before a given action can be taken
1. Procedural step	Steps of a procedure which must be completed in the specified order
↳ Result	Result of a procedural step
• Enumeration	Bullet lists
– Enumeration	
Figure 1: Caption	Description of the content of a figure
Table 1:	Description of the content of a table
Footnote	Comment

3.2 Definition of Terms

A block is the smallest unit. A group of two or more blocks is called a battery. For example, this can involve several blocks connected in series (e.g. a traction battery) or a group of batteries consisting of two or more blocks in a UPS system.

Measurements can be conducted for individual blocks or batteries. From an organizational standpoint, a device under test is always set up in the battery tester as a battery which includes one or more blocks which will be measured. And thus if you only want to measure one block, set up a battery with just one block.

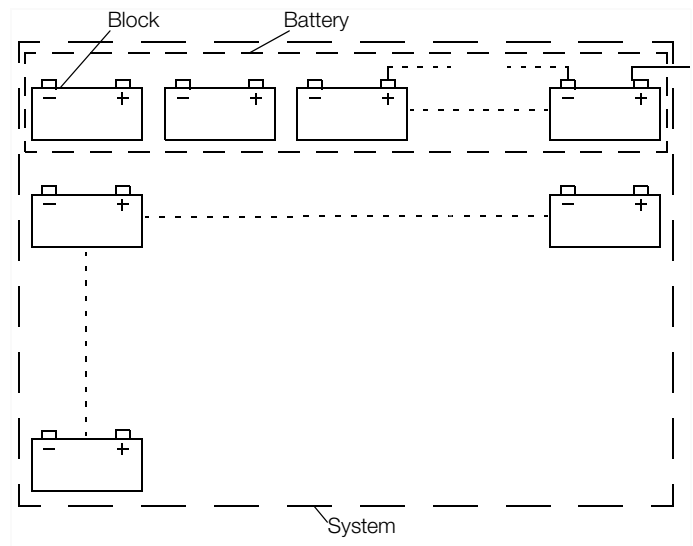













Figure 2: Example – Blocks and Battery within a System

4 Getting Started

1. Read and adhere to the product documentation. In particular observe all safety information in the documentation, on the instrument and on the packaging.
 - ⇒ “Safety Precautions”  1
 - ⇒ “Important Information”  2
 - ⇒ “Documentation”  2
2. Familiarize yourself with the battery tester.
 - ⇒ “The Instrument”  3
 - ⇒ “Operation”  7
 - ⇒ “Menu and Functions”  10
3. Install BT PRO Manager software and familiarize yourself with the program ⇒  18.
4. Create a battery database ⇒  20.
5. Complete all required preparation in order to be able to perform measurements ⇒  18.
6. Perform measurements ⇒  30.
7. Evaluate your measurements ⇒ “Viewing, Editing, Transferring and Evaluating Measured Values”  50.

5 The Instrument

5.1 Scope of Delivery

Please check for completeness.

- 1 METRACELL BT PRO
- 1 Rubber holster
- 4 1.2 V AA batteries
- 1 Power pack
- 1 Set of multimeter test probes (KS29)
- 2 Alligator clips (KY95-3)
- 1 Set of Kelvin probes for 4-wire measurement (Z227D)
- 1 Carrying strap
- 1 Carrying case
- 1 BT PRO Manager (battery tester management software)
- 1 Test report / factory calibration certificate
- 1 Condensed operating instructions

5.2 Optional Accessories

Some measurements necessitate optional accessories:

- AC/DC current clamp sensor
 - CP1800 (Z204A) for measurements up to 1250 A_{DC} or
 - CP330 (Z202B) for measurements up to 300 A_{DC}
- METRATHERM IR BASE temperature sensor (Z680A)
- Spring-loaded contact pins as replacement parts for the Kelvin probes (Z227F)

Please contact our product support team for further information on accessories ⇒  53.

Values recorded by and stored at the DMA 35 portable density meter from Anton Paar GmbH can be transferred to the battery tester. A description of how to use the density meter with the METRACELL BT PRO is included in these operating instructions (⇒  30). Please contact Anton Paar GmbH for any further information concerning the DMA 35 density meter.

5.3 Instrument Overview

Front



Figure 3: Front Panel

No.	Function
1	Rubber holster (removable)
2	Infrared interface
3	Charging socket (charging cable connection)
4	Measurement input S-
5	Measurement input P-/COM
6	Measurement input S+
7	Measurement input P+
8	Carrying strap eyelets
9	Function keys
10	Display
11	RFID reader

Back

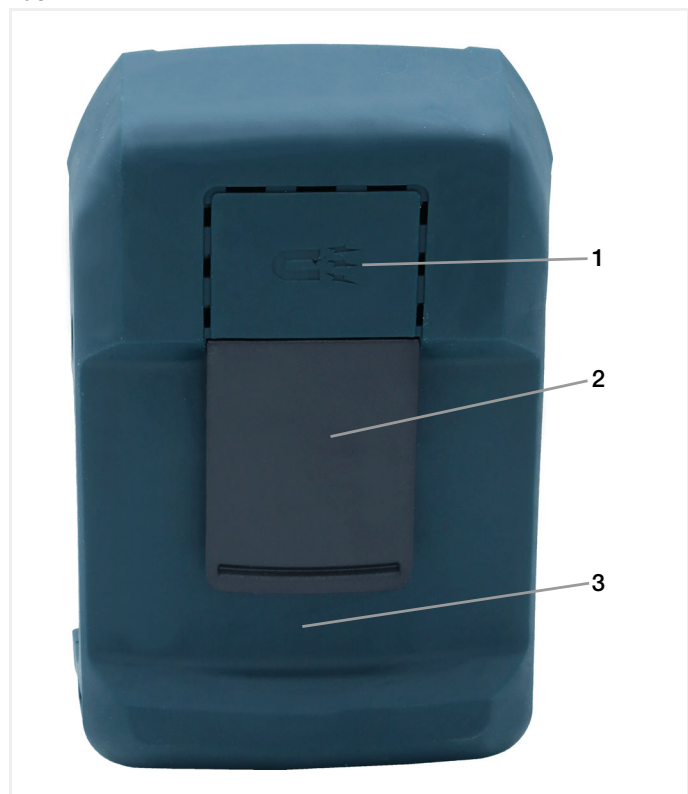

Figure 4: Back of Instrument

No.	Function
1	Retaining magnet
2	Retaining clip
3	Battery compartment cover (underneath the holster)

Symbols on the instrument and the included accessories:



Warning concerning a point of danger (attention, observe documentation!)



Double insulation (protection category II)

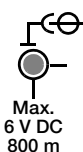

Charging socket location (⇒ "Instrument Overview" 3)



Attention!

Attention!
Only rechargeable NiMH batteries may be inserted when the charger is connected.



Fuse



Infrared interface location



Static magnetic field



European conformity marking



The device may not be disposed of with household trash ⇒ "Returns and Environmentally Sound Disposal" 54.

5.4 Relevant Standards

The battery tester has been manufactured and tested in accordance with the following safety regulations:

IEC 61 010-1 EN 61 010-1 VDE 0411-1	Safety requirements for electrical equipment for measurement, control and laboratory use – General requirements
EN 60 529 VDE 0470, part 1	Test instruments and test procedures Degrees of protection provided by enclosures (IP code)
DIN EN 61 326-1 VDE 0843-20-1	Electrical equipment for measurement, control and laboratory use – EMC requirements – Part 1: General requirements

5.5 Measurement Inputs

All measurement inputs are referenced to ground and reference potential, P-/COM input. The measurement inputs are not electrically isolated from each other.

The measuring ranges depend on the respective measurement inputs.

Measurement input	Function
S-	Input for measuring DC voltage. Measuring range: $\pm 2450.00 \text{ mV}_{\text{DC}}$ Resolution: 0.01 mV Input impedance: $> 10 \text{ M}\Omega$ Sensing lead to minus pole during resistance measurement.
P-/COM	Reference potential (ground potential) of all measurement inputs. Current conducting cable to minus pole during resistance measurement.
S+	Measurement input for direct and alternating voltage measurements. Measuring ranges: $\pm 24.5000 \text{ V}_{\text{DC}}$ Resolution: 0.1 mV $\pm 600.000 \text{ V}_{\text{DC}}$ Resolution: 1 mV $\pm 300.000 \text{ V}_{\text{AC}}$ Resolution: 10 mV Input impedance: $1.6 \text{ M}\Omega$ Sensing lead to plus pole during resistance measurement.
P+	Current conducting cable to plus pole during resistance measurement.

⚠ Attention!
Max. 24 V_{DC}
 Maximum test voltage must not exceed 24 V DC at input P+.
 The instrument is damaged if this value is exceed.



Note
600 V CAT III refers to measurement inputs S+, S- and P-/COM.

5.6 LCD Display

All measured values, functions and settings can be observed at the instrument's display. As a rule, the display at the LCD panel appears in two lines. Three and four-line displays are also used in some cases, for example with measured values.

After switching the battery tester on, the initial display appears including the instrument's designation and the version, as well as date and time.



Figure 5: Figure: Initial Display

After pressing any key while the initial display is shown, the battery tester is switched to the main menu.

All other displays and information which appear at the instrument depend on the previously selected function. The currently selected function is always identified by a preceding arrow ->.

5.7 Function Keys / Navigation

Key	Function
	"Function" key - Switch on and off (⇔ 7) - Press briefly: Return to next higher menu level or cancel measurement - Press and hold: End (⇔ 30) or reactivate (⇔ 30) measurement
	Scroll down key "▼" Selection of menu items or digits in downward direction.
	Scroll up key "▲" Selection of menu items or digits in upward direction.
	"OK" key - Open menus - Execute functions - Confirm entries - Select digits - Proper termination of measurements - Press and hold: repeat measurement (⇔ 31)

5.8 RFID Reader

The display is surrounded by an RFID reader. If individual batteries are equipped with an RFID tag (transponder), the tag can be scanned before measurement, thus making it possible to subsequently assign the measurement data to the respective DUT automatically ⇔ 32.

125 kHz Technology

The RFID reader can only read RFID tags which use a frequency of 125 kHz. This technology offers several advantages:

- As one of the first RFID technologies, it's widely used and easy to obtain.
- It uses robust tags which are relatively insensitive to interference from metals and liquids, which is crucial in battery environments.
- Universal use (license-free ISM band)
- Minimal energy consumption (low-frequency long-wave band – LF passive tags)
- Reading range: approx. 10 cm
- Small data transfer volumes with fast reading process (e.g. only object ID as battery identification)

Reading RFID Tags

In order to read an RFID tag, hold the battery tester display 1 to 2 cm above the RFID tag. **RF** appears at display.

5.9 Attachment Options

The battery tester provides acoustic feedback for all important procedural steps, e.g. readiness to record measured values. Consequently, there's no need to continuously observe the display.

In order to ensure freedom of movement, comfort and quick work for the operator, the battery tester can be secured by means of various retaining devices for the entire duration of measurement:

- Carrying strap:
The operator can use the carrying strap to suspend the battery tester around his neck. The condensed operating instructions ⇔ include a description of how to attach the carrying strap.
- Retaining clip:
The operator can attach the battery tester to his belt with the help of the retaining clip.
- Retaining magnet:
The battery tester can be attached to magnetic surfaces such as battery cabinet doors with the retaining magnet.

5.10 Technical Data

Power Supply	Rechargeable NiMH batteries, 4 ea. 1.2 V type AA (recommended: Ansmann maxE 2500 mAh)
Input Impedance	Measurement input S+: 1.6 M Ω Measurement input S-: > 10 M Ω
Ambient Conditions	Operating temperature: +5 ... +40 °C Storage temperature: -20 ... +60 °C Relative humidity: Max. 75%, no condensation allowed Elevation: Max. 2000 m
Electrical Safety	Measuring category: 600 V CAT III Pollution degree: 2 Protection category: II per IEC 61 010-1/EN 61010-1/VDE 0411-1 Fuse link: 1 ea. SIBA 600 V/10 A FF Test Voltage: Test voltage at measuring connection P+ may not exceed 24 V _{DC} .
Electromagnetic Compatibility (EMC)	Interference emission: EN 61326-1:2013, class A Interference immunity: EN 61 326-1:2013 EN 61326-2-1:2013
Mechanical Design	Protection: Housing: IP40 per DIN VDE 0470, part 1/EN 60 529 (protection against ingress of solid foreign objects: ≥ 1.0 mm dia., protection against ingress of water: not protected) Housing: Approx. 9.6 x 15.4 x 3.3 cm (W x H x D) Weight: Approx. 0.45 kg (without rubber holster) Display: LCD, monochrome, luminous
Data Interfaces	IrDA: Connection for DMA 35 density meter, version 3 RFID: Connection for RFID tag Bluetooth®: Connection for PC, headset and DMA 35 density meter, version 4
Internal Memory	Up to 300,000 data records

**Note**

Technical data for the AC/DC current clamp sensors, the temperature sensor and the DMA 35 density meter can be found in the respective product documentation.

5.11 Characteristic Values

Measuring Function	Multimeter/ Connector	Multimeter/ Float/ Discharge/Charge	Multimeter/ Interval U/ Internal U+I	Multimeter	Resistance	Temperature
Measured Quantity	V _{DC}	V _{DC}	V _{DC}	V _{AC}	R _{el} + R _{ct}	°C
Display Range	-2450.00 ... +2450.00 mV	-24.5000 ... +24.5000 V	-600.000 ... +600.000 V	-300.000 ... +300.000 V	00.00 ... 1000.00 m Ω	-230.0 ... +230.0 °C ¹⁾
Measuring Range	-2450.00 ... +2450.00 mV	-24.5000 ... +24.5000 V	-600.000 ... +600.000 V	-300.000 ... +300.000 V	00.10 ... 1000.00 m Ω	
Resolution	0.01 mV	0.1 mV	1 mV	10 mV	0.01 m Ω	0.1 °C
Input Impedance / Test Current	> 10 M Ω	1.6 M Ω	1.6 M Ω	1.6 M Ω	I _p approx. 2 A	> 10 M Ω
Intrinsic Uncertainty	$\pm(0.05\%$ rdg. + 10 d)	$\pm(0.05\%$ rdg. + 10 d)	$\pm(0.05\%$ rdg.+ 50 d)	$\pm(2.0\%$ rdg. + 10 d) ²⁾	$\pm(3.0\%$ rdg. + 8 d)	
S+		•	•	•	•	
S-	•				•	•
P+					•	
P-/ COM	•	•	•	•	•	•

¹⁾ Only applicable if the temperature sensor is connected to the battery tester.

²⁾ Within a frequency range of 45 to 500 Hz.

**Note**

The characteristic values of the AC/DC current clamp sensors and the DMA 35 density meter, as well as additional characteristic values for the temperature sensor, can be found in the respective product documentation.

6 Operation

6.1 Power Supply (rechargeable batteries)

Battery Operation

The battery tester is operated with rechargeable NiMH batteries. Pre-charged batteries are shipped loose. You have already inserted the batteries during initial startup (⇒  condensed operating instructions).

Operating time is approximately 10 hours when the batteries are fully charged. A warning is generated when battery voltage drops to below 4.8 V. The battery tester can be operated for approximately 1 more hour after this warning is generated.

Attention!

Leaking batteries can damage the device. Check the batteries at short, regular intervals and after long periods of storage.

Charging Process

It takes about 3½ hours to charge the batteries.

Attention!



Damage to the batteries or the instrument. When charging, use only:

- The included rechargeable batteries or the batteries specified in the technical data
- The included charger

Always connect the battery charger to the battery tester before connecting the charger to the electrical outlet.

Note

Do not switch the battery tester on during charging. The battery tester may not be operated during charging and is switched off automatically after 3 seconds.

- ✓ The battery tester is switched off.
 - ✓ 4 NiMH batteries are inserted (see section on "Replacing the Batteries" ⇒  7 for information on inserting batteries).
 - ✓ All measurement cables and accessories must be removed from the battery tester.
1. Insert the charger's connector plug into the battery tester's charging socket ⇒ "Instrument Overview"  3.
 2. Connect the charger to the 230 V mains outlet. The batteries in the battery tester are charged.
 3. Wait until the charging process has been completed. It takes about 3½ hours to fully charge the batteries.
 4. Unplug the charger from the electrical outlet.
 5. Remove the connector plug from the battery tester's charging socket.
- ↳ The batteries are charged. The battery tester can now be used.

Replacing the Batteries

You can replace the batteries if necessary.

Attention!

Risk of injury due to contact with dangerous voltages. Only use the battery tester when the battery compartment cover is inserted and firmly screwed into place.

- ✓ The battery tester must be switched off.
 - ✓ All measurement cables and accessories must be removed from the battery tester.
1. Remove the holster from the battery tester: Press against the bottom of the holster at the front and push it back and off of the battery tester. As soon as the lower part of the battery tester is exposed, pull the instrument completely out of the holster.
 2. Place the battery tester face down on a stable surface.
 3. Loosen and remove the screw from the battery compartment cover.
 4. Unlock and remove the battery compartment cover.
 5. Remove any batteries from the battery compartment.
 6. Insert 4 approved rechargeable batteries into the battery compartment, making sure that the plus and minus poles match up with the provided polarity symbols.

Attention!

Only the included batteries or those specified in the technical data (⇒  6) may be inserted and used.

7. Place the battery compartment cover onto the battery compartment and press it until it audibly clicks into place.
 8. Secure the battery compartment cover with the screw.
 9. Pull the holster back over the battery tester: Observe the cut-outs in the holster for the front panel and the connections. Push the battery tester into the holster at the top first as far as it will go. Then press on the front at the bottom until the battery tester is fully reinserted into the holster.
- ↳ The batteries have now been inserted. The battery tester can be used.

6.2 Switching the Instrument On/Off

Switching the Instrument On

1. Press and hold the **Function** key for approximately 2 seconds. The initial display appears with the instrument's designation and version, as well as date and time (⇒ "LCD Display"  5).
 2. Press any key.
- ↳ The **main menu** appears at the display. The battery tester can now be used.

Switching the Battery Tester Off

Normally, the battery tester is switched off manually. If the battery tester has not been used for more than 10 minutes, it's switched off automatically.

1. Select → **POWER OFF** in the **main menu** with the help of the ▼ key.
 2. Press the **OK** key.
- ↳ The display goes blank. The battery tester has been switched off.

Note

The battery tester can also be switched off by pressing the **Function** key. The key must be pressed and held for approximately 10 seconds to this end. However, it's preferable to switch the instrument off using the **SWITCH OFF** function.

Required tools: Philips screwdriver

6.3 System Settings

You can enter basic settings to the battery tester.

Setting Date and Time



Note

Switch back and forth between standard time and daylight savings time manually. The battery tester is not equipped with an automatic time change function.

1. Switch the battery tester on ⇨ 7.
 2. Press the **OK** key.
The **main menu** appears.
 3. Select → **SETTINGS** from the **main menu** using the ▼ ▲ keys.
 4. Press the **OK** key.
The **SETTINGS** menu is displayed.
 5. Select → **SYSTEM** using the ▼ ▲ keys.
 6. Press the **OK** key.
The **SYSTEM** menu is displayed.
 7. Select → **SET TIME&DATE** using the ▼ ▲ keys.
 8. Press the **OK** key.
The **SET TIME&DATE** menu is displayed. The cursor is positioned at the first digit of the date display (dd.mm.yy: dd = day, mm = month and yy = year).
 9. Use the ▼ ▲ keys to enter the first digit of the two-digit display for the current day.
 10. Press the **OK** key to move to the second digit.
 11. Repeat steps 9. and 10. until the date has been completely entered.
After entering and confirming the last digit for the year, the cursor jumps to the first digit of the time display (ss:mm:hh: ss = second, mm = minute and hh = hour)
 12. Set the digits for time in the same way as described for setting the date.
After entering the last digit for current time, your settings are saved. The **SYSTEM** menu is displayed.
- ↳ Date and time have been set.

Language Selection

Device language can be set to either English or German.

1. Switch the battery tester on ⇨ 7.
 2. Press the **OK** key.
The **main menu** appears.
 3. Select → **SETTINGS** from the **main menu** using the ▼ ▲ keys.
 4. Press the **OK** key.
The **SETTINGS** menu is displayed.
 5. Select → **SYSTEM** using the ▼ ▲ keys.
 6. Press the **OK** key.
The **SYSTEM** menu is displayed.
 7. Select → **SEL. LANGUAGE** using the ▼ ▲ keys.
 8. Press the **OK** key.
The **SEL. LANGUAGE** menu is displayed.
 9. Select the desired language using the ▼ ▲ keys.
 10. Press the **OK** key.
- ↳ The device language is changed.

6.4 Establishing and Terminating Wireless Connections

The battery tester can be wirelessly connected to various devices:

- To the DMA 35 density meter from Anton Paar GmbH
 - DMA 35 version 3 via infrared ⇨ “DMA35 Measurement (IrDA)” 49
 - DMA 35 version 4 via Bluetooth® ⇨ “DMA35 Measurement (BT)” 49
- To a PC in order to view, evaluate and save measurement data ⇨ “Saving Measured Values to a PC (data backup)” 50
- To a headset for improved audibility of signals generated by the instrument ⇨ “Establishing and Testing a Bluetooth® Connection with a Headset” 8



Note

Although the battery tester can be paired with several devices via Bluetooth®, simultaneous operation with several devices via Bluetooth® is not possible.

Bluetooth® connections can be terminated when they're no longer needed.



Note

In case of connection problems, it may be helpful to terminate (⇨ 9) and reestablish Bluetooth® connections (see references to specific sections above).

Establishing and Testing a Bluetooth® Connection with a Headset

Acoustic signals are used to confirm various actions before, during and after a measuring procedure, as well as certain instrument reactions.

The instrument can be paired with a headset, making it possible to better hear these signals in noisy work environments. The connection can be checked in advance with a test signal.



Note

Read and adhere to the documentation included with your headset.

- ✓ The headset supports Bluetooth® profile “HSP”.
1. Switch the battery tester on ⇨ 7.
 2. Press the **OK** key.
The **main menu** appears.
 3. Select → **SETTINGS** from the **main menu** using the ▼ ▲ keys.
 4. Press the **OK** key.
The **SETTINGS** menu is displayed.
 5. Select → **BT-SETTINGS** using the ▼ ▲ keys.
The **BT-SETTINGS** menu is displayed.
 6. Select → **LINK HEADSET** using the ▼ ▲ keys.
 7. Press the **OK** key.
 8. The **PUT HEADSET IN PAIRING MODE** -> prompt appears.
 9. Set the headset to pairing mode. Read the documentation included with your headset to find out how.
 10. Position the headset close to the battery tester.
 11. Acknowledge the **PUT HEADSET IN PAIRING MODE** -> prompt by pressing the **OK** key.
BT PAIRING: SEARCH HEADSET! appears at the display.
 12. The headset and the battery tester are connected to each other. Pairing progress is displayed as a percentage. As soon as the devices are successfully connected, **SUCCESSFUL!** appears at the display.
 13. Put on the headset.
 14. Press the **OK** key.
The **BT-SETTINGS** menu is displayed.
 15. Press the **Function** key.
The **main menu** appears.
 16. Select → **SETTINGS** from the **main menu** using the ▼ ▲ keys.
 17. Press the **OK** key.
The **SETTINGS** menu is displayed.
 18. Select → **SYSTEM** using the ▼ ▲ keys.
 19. Press the **OK** key.
The **SYSTEM** menu is displayed.
 20. Select → **TEST HEADSET** using the ▼ ▲ keys.
 21. Press the **OK** key.
- ↳ A test signal is played back at the headset.

Terminating the Bluetooth® Connection

All paired devices are disconnected when the Bluetooth® connection is terminated. It's not possible to disconnect individual devices.

1. Switch the battery tester on ⇨ 7.
 2. Press the **OK** key.
The **main menu** appears.
 3. Select → **SETTINGS** from the **main menu** using the ▼ ▲ keys.
 4. Press the **OK** key.
The **SETTINGS** menu is displayed.
 5. Select → **BT-SETTINGS** using the ▼ ▲ keys.
The **BT-SETTINGS** menu is displayed.
 6. Select → **REM. PAIRINGS** using the ▼ ▲ keys.
 7. Press the **OK** key.
The **DO YOU REALLY WANT TO DELETE?** prompt appears.
 8. Press the **OK** key.
DELETING DATA! PLEASE WAIT appears briefly at the display.
REM. PAIRINGS appears at the display.
- ↳ Bluetooth® connection to all paired devices has now been terminated.

6.5 Testing the RFID Reader

The RFID reader can be tested (⇨ 5).

- ✓ A compatible RFID tag (125 kHz) is available.

1. Switch the battery tester on ⇨ 7.
 2. Press the **OK** key.
The **main menu** appears.
 3. Select → **SETTINGS** from the **main menu** using the ▼ ▲ keys.
 4. Press the **OK** key.
The **SETTINGS** menu is displayed.
 5. Select → **SYSTEM** using the ▼ ▲ keys.
 6. Press the **OK** key.
The **SYSTEM** menu is displayed.
 7. Select → **TEST TRANSP.** using the ▼ key.
 8. Press the **OK** key.
WAITING FOR RFID -----> () <----- appears at the display.
Furthermore, a repetitive acoustic signal indicates readiness to read.
 9. Hold the battery tester's RFID reader roughly 1 to 2 cm above the RFID tag.
- ↳ The RFID tag is read. The RFID tag's number appears at the display.































Refer to section on "Performing Measurements" ⇨ 30 on how to assign RFID tags to DUTs and read them out during measurement.

7 Menu and Functions

7.1 Overview

On	Main Menu Level		1 st Submenu Level		2 nd Submenu Level		3 rd Submenu Level		4 th Submenu Level			
Start	Display	Keys	Display A	Keys	Display	Keys	Display	Keys	Display	Keys		
<p>Initial Display</p> <p>2 sec.</p>	MEASUREMENT		MULTIMETER		2.45 V DC (S-)		Start measurement (short tone), end measurement (short tone), display value		End measured value recording, return to MULTIMETER display			
					24.5 V DC (S+)							
					600 V DC (S+)							
					300 V AC (S+)							
					QUIT						OK ←	
			FLOAT		START		Start measurement (short tone), end measurement (short tone), display value		WANT TO QUIT WITH SAVING? WANT TO QUIT WITHOUT SAVING?		OK ←	
							WAITING FOR DMA35	→				
							DISCHARGE		SELECT.BATT		Battery database display, brief tone indicates RFID readiness to read	
			CHARGE		AREA: XXXX						AREA: 0000	
			RESISTANCE									
			TEMPERATURE		BATTERY: XXXX		BATTERY: 0000					
												CONNECTOR
	INTERVAL U		BLOCKS XXXX*		BLOCKS: 0000							
										INTERVAL U+I		
	DMA35 (IrDA)		MIN: XX.XXX [U/M]		MIN: 0000 [U/M]							
										DMA35 (BT)		
	MAX: XX.XXX [U/M]		INT [s]: XXXX**		INT [s]: 0000							
										CLAMP A: XXXX ***		
	CLAMP mV: XXXX ***		QUIT		QUIT							
										QUIT	OK ←	
	DATA MENU			SHOW DATA		Display of measurement with indication of measurement type, date, time etc.		Display measured values (see key)		Repeat measurement		
						EXPORT (CSV)		BT CSV EXPORT (CONNECT)	- - -		DEVICE PAIRED? EXPORT TARGET OK?	
				SHOW BAT-DEF		Battery database display, brief tone indicates RFID readiness to read		In case of manual selection, return to display. In case of RFID, display read result.		For RFID OK ←		
CLEAR BAT-DEF					DO YOU REALLY WANT TO DELETE?		DELETING DATA! PLEASE WAIT!				Brief tone indicates deletion, return to CLEAR DATA/ BATT. display	
												QUIT

(continued)

On Start	Main Menu Level		1 st Submenu Level		2 nd Submenu Level		3 rd Submenu Level		4 th Submenu Level		
	Display	Keys	Display A	Keys	Display	Keys	Display	Keys	Display	Keys	
	SETTINGS		SYSTEM		SET TIME&DATE		DATE: XX.XX.X TIME: XX:XX:XX				
					SEL. LANGUAGE		ENGLISH DEUTSCH		Menu is displayed in selected language, return to SEL. LANGUAGE display		
					TEST HEADSET		Read out test signal		- - -		
					TEST TRANSP.		WAITING FOR RFID -----> () <----- -			WAITING FOR RFID <RFID Number>	→
					QUIT		 ←				
			MEASUREMENTS		POLARITY ON		POLARITY ON		Brief tone signals selection, display remains in menu		
					POLARITY OFF		POLARITY OFF				
					QUIT		 ←				
			BT-SETTINGS		LINK COMPUTER		BT PAIRING: WAITING FOR PC		List with all detected BT devices is displayed.	→	
					LINK HEADSET		PUT HEADSET IN PAIRING MODE ->			BT PAIRING: SEARCH HEADSET	→
					LINK DMA35 V4		PLEASE DISCOVER BTpro WITH DMA35			→	
					REM. PAIRINGS		DO YOU REALLY WANT TO DELETE?			DELETING DATA! PLEASE WAIT!	←
					QUIT		 ←				
			CSV-EXPORT		EXPORT TARGET		SCANNING FOR BT DEVICES.		NO BT DEVICES FOUND	 ←	
					FILENA. FIXED		FILENA. FIXED			Detected BT devices are listed	→
					FILEN. UNIQ.		FILEN. UNIQ.				
					QUIT		 ←				
			FACTORY ONLY		FACTORY USE ONLY PASSWORD: XXXXX						
					QUIT	 ←					
			INFO		VERSION: VX.XX ENTRIES: XXX% MEMORY: XXX% BATTERY: XXX%	 ←					
			POWER OFF								

General Key	
-> MEASUREMENT DATA	Display menu/function, the arrow indicates the selected function.
DELETING DATA PLEASE WAIT	Feedback or information after action
BLOCK 12.2500V 0004/4	Display measured value (example) Display measured value evaluation
AN:0001 BN:0010	
Descriptive text	Explanation of measured value, parameter and other displays
	Scroll within menu levels and functions.
	Start function, submenu selection
	Switch on, termination of an action currently being executed
	Move up one view in the menu.
	Move down one view in the menu.
	Jump to submenu level (press briefly).
	Jump to submenu level (press and hold).
	Jump back to higher menu level (initial position).
	Remains at current position.
	No action required.
	Further action and displays depend on systems to be linked or downstream systems.
	Currently selected digit (display with black background).
X	Placeholder for one digit.
*	Parameter not for measuring functions INTERVAL U and INTERVAL U+I
**	Parameters only for measuring functions INTERVAL U and INTERVAL U+I
***	Parameters only for measuring functions INTERVAL U and INTERVAL U+I

A	Set/select special key assignments for parameters
	Cursor for selecting the digit to be changed (inverted cursor), storage takes place after selection of the last digit, then return to higher menu level
	Increase digit
	Decrease digit
	Cancel entry/selection of digits without saving, return to higher menu level

B RFID tags must be held roughly 1 to 2 cm above the display

7.2 Display Menu

The initial display appears after switching the battery tester on (→ 7). The **main menu** is then displayed after pressing any key. If you're already in a submenu, press the **FUNCTION** key repeatedly until the display is returned to the **main menu**.

This is the central menu from which all other hierarchically subordinate menus and functions can be accessed. All **main menu** functions can be selected with the help of the ▼ ▲ keys.

Table 10: List of Functions Available in the **Main Menu**

Function	Description
MEASUREMENT	Available measuring functions → 12
DATA MENU	Data management functions → 15
SETTINGS	Parameter settings for system, measurements and data transfer → 16
INFO	Information concerning firmware version, battery charge level and memory occupancy → 17
POWER OFF	Switch off the battery tester → 7.



7.3 Measurement Menu

Select → **MEASUREMENT** in the **main menu** and then press the **OK** key in order to open the menu.

Table 11: List of Functions Available in the **MEASUREMENT** Menu

Measurement	Description
MULTIMETER	DC and AC voltage measurements without storing measured values
FLOAT	Periodic measurement of block voltages. This measurement is used for quarterly recording of float voltage, for example in UPS systems.
DISCHARGE	Multiple measurement of block voltages at short intervals during discharging (capacity test)
CHARGE	Multiple measurement of block voltages at short intervals during charging (capacity test)
RESISTANCE	Periodic measurement of the internal resistance of the blocks
TEMPERATURE	Measurement of block temperature with an IR temperature sensor
CONNECTOR	Measurement of voltage drop to determine connector loss between blocks
INTERVAL U	Measurement of the voltage of a battery at any desired time intervals (voltage curve)
INTERVAL U + I	Measurement of the voltage and current of a battery at any desired time intervals (voltage and current curves) Example: Recording of discharge current during discharging.
DMA 35 (IrDA)	Measurement of acid density and electrolyte temperature within a block. Measurements are performed with the DMA 35 density meter (version 3) from Anton Paar GmbH. Data are transferred from the sensor to the battery tester via infrared (Infrared Data Association – IrDA).
DMA 35 (BT)	Measurement of acid density and electrolyte temperature within a block. Measurements are performed with the DMA 35 density meter (version 4) from Anton Paar GmbH. Measured values are transferred from the sensor to the battery tester via Bluetooth®.
QUIT	Exit the MEASUREMENT menu and return to the main menu .

 **Note**

The required parameters for the device under test must be defined before starting a measurement. Use the battery database to this end (⇒ “Performing Measurements”  30 and ⇒ “Transferring the Battery Database to the Battery Tester”  23).
Manual entries should only be made in exceptional cases.

Multimeter

Select the → **MEASUREMENT** → **MULTIMETER** function sequence via the **main menu** and press the **OK** key in order to open the menu.

Table 12: Possible Measuring Ranges for **MULTIMETER** Measurement

Measuring Range	Description
2.45 V _{DC} (S-)	Measuring range selection for direct voltage measurement via measuring socket S-
24.5 V _{DC} (S+)	Measuring range selection for direct voltage measurement via measuring socket S+
600 V _{DC} (S+)	Measuring range selection for direct voltage measurement via measuring socket S+
300 V _{AC} (S+)	Measuring range selection for alternating voltage measurement via measuring socket S+
QUIT	Return to MEASUREMENT menu

Float, Discharge, Charge and Resistance

In order to open the menu, select one of the following function sequences from the **main menu**:

→ **MEASUREMENT** → **FLOAT** or → **MEASUREMENT** → **DISCHARGE** or → **MEASUREMENT** → **CHARGE** or → **MEASUREMENT** → **RESISTANCE**, and then press the **OK** key.

Table 13: Parameters and Functions for the **FLOAT**, **DISCHARGE**, **CHARGE** and **RESISTANCE** Measurements

Function/Setting	Description
START	Measurement is started after selecting or entering the battery parameters.
SELECT.BATT	The menu for selecting and loading a stored battery database is accessed via this function. If a database exists, the stored data records appear.
AREA: XXXX	Manual assignment of a unique four-digit number for the location of the battery system
BATTERY: XXXX	Manual assignment of a unique four-digit number as a designation of the battery in the battery system
BLOCKS:XXXX	Manual assignment a unique four-digit number identifying the number of blocks within the battery
MIN: XX.XXX V	Manual measuring range setting: lower voltage limit value
MAX: XX.XXX V	Manual measuring range setting: upper voltage limit value (max. +24.50 V)
QUIT	Return to MEASUREMENT menu

Temperature

Select the → **MEASUREMENT** → **TEMPERATURE** function sequence via the **main menu** and press the **OK** key in order to open the menu.

Table 14: Parameters and Functions for the **TEMPERATURE** Measurement

Function/Setting	Description
START	Measurement is started after selecting or entering the battery parameters.
SELECT.BATT	The menu for selecting and loading a stored battery database is accessed via this function. If a database exists, the stored data records appear.
AREA: XXXX	Manual assignment of a unique four-digit number for the location of the battery system
BATTERY: XXXX	Manual assignment of a unique four-digit number as a designation of the battery in the battery system
BLOCKS:XXXX	Manual assignment a unique four-digit number identifying the number of blocks within the battery
MIN: XXXX.X C	Manual measuring range setting: lower temperature limit value (max. -230 °C)
MAX: XXXX.X C	Manual measuring range setting: upper temperature limit value (max. +230 °C)
QUIT	Return to MEASUREMENT menu

Start / Battery Parameters Menu for Connector Measurement

Select the → **MEASUREMENT** → **CONNECTOR** function sequence via the **main menu** and press the **OK** key in order to open the menu.



Table 15: Parameters and Functions for the **CONNECTOR** Measurement

Function/Setting	Description
START	Measurement is started after selecting or entering the battery parameters.
SELECT.BATT	The menu for selecting and loading a stored battery database is accessed via this function. If a database exists, the stored data records appear.
AREA: XXXX	Manual assignment of a unique four-digit number for the location of the battery system
BATTERY: XXXX	Manual assignment of a unique four-digit number as a designation of the battery in the battery system
BLOCKS:XXXX	Manual assignment a unique four-digit number identifying the number of blocks within the battery
MIN: XXXX.X mV	Manual measuring range setting: lower voltage limit value
MAX: XXXX.X mV	Manual measuring range setting: upper voltage limit value (max. +2400.0 mV)
QUIT	Return to MEASUREMENT menu

Start / Battery Parameters Menu for Interval U Measurement

Select the → **MEASUREMENT** → **INTERVAL U** function sequence via the **main menu** and press the **OK** key in order to open the menu.

Table 16: Parameters and Functions for the **INTERVAL U** Measurement



Function/Setting	Description
START	Measurement is started after selecting or entering the battery parameters.
SELECT.BATT	The menu for selecting and loading a stored battery database is accessed via this function. If a database exists, the stored data records appear.
AREA: XXXX	Manual assignment of a unique four-digit number for the location of the battery system
BATTERY: XXXX	Manual assignment of a unique four-digit number as a designation of the battery in the battery system
INT [s]: XXXX	Manually adjustable time interval (in seconds) for recording the measured value. (min. 1 second)
MIN: XXX.XX V	Manual measuring range setting: lower voltage limit value  Note Same as discharge cut-off voltage. If the limit value is fallen short of, the instrument generates an acoustic signal at regular intervals. This indicates that the discharging process has been completed and measurement can be ended.
MAX: XXX.XX V	Measuring range setting: upper voltage limit value  Note Same as charge cut-off voltage. If the limit value is exceeded, the instrument generates an acoustic signal at regular intervals. This indicates that the charging process has been completed and measurement can be ended. (max. +600 V)
QUIT	Return to MEASUREMENT menu

Interval U + I

Select the → **MEASUREMENT** → **INTERVAL U+I** function sequence via the **main menu** and press the **OK** key in order to open the menu.

Table 17: Parameters and Functions for **INTERVAL U+I** Measurements

Function/Setting	Description
START	Measurement is started after selecting or entering the battery parameters.
SELECT.BATT	The menu for selecting and loading a stored battery database is accessed via this function. If a database exists, the stored data records appear.
AREA: XXXX	Manual assignment of a unique four-digit number for the location of the battery system
BATTERY: XXXX	Manual assignment of a unique four-digit number as a designation of the battery in the battery system
INT [s]: XXXX	Manually adjustable time interval (in seconds) for recording the measured value. (min. 1 second)

Function/Setting	Description
MIN: XXX.XX V	Manual measuring range setting: lower voltage limit value  Note Same as discharge cut-off voltage. If the limit value is fallen short of, the instrument generates an acoustic signal at regular intervals. This indicates that the discharging process has been completed and measurement can be ended.
MAX: XXX.XX V	Manual measuring range setting: upper voltage limit value  Note Same as charge cut-off voltage. If the limit value is exceeded, the instrument generates an acoustic signal at regular intervals. This indicates that the charging process has been completed and measurement can be ended. (max. +600 V)
CLAMP A: XXXX	Manual measuring range setting: Current value of the transformation ratio of the current clamp
CLAMP mV: XXXX	Manual measuring range setting: Voltage value of the transformation ratio of the current clamp
QUIT	Return to MEASUREMENT menu

DMA35 (IrDA and Bluetooth®)

Select the → **MEASUREMENT** → **DMA35 (IrDA)** or → **DMA35 (BT)** function sequence via the **main menu** and then press the **OK** key in order to open the menu.

Table 18: Parameters and Functions for the **DMA35 (IrDA)** and **DMA35 (BT)** Measurements

Function/Setting	Description
START	Measurement is started after selecting or entering the battery parameters.
SELECT.BATT	The menu for selecting and loading a stored battery database is accessed via this function. If a database exists, the stored data records appear.
AREA: XXXX	Manual assignment of a unique four-digit number for the location of the battery system
BATTERY: XXXX	Manual assignment of a unique four-digit number as a designation of the battery in the battery system
BLOCKS:XXXX	Manual assignment a unique four-digit number identifying the number of blocks within the battery
MIN: X.XXXX	Manual measuring range setting: lower limit value for acid density
MAX: X.XXXX	Manual measuring range setting: upper limit value for acid density
QUIT	Return to MEASUREMENT menu

7.4 Data Menu

Select → **DATA MENU** in the **main menu** and then press the **OK** key in order to open the menu.

Table 19: Functions in the **DATA** Menu

Function	Description
SHOW DATA	Display of stored measured values
EXPORT (CSV)	Transfer of stored measured values to the PC as CSV file
SHOW BATT-DEF	Display of the battery database
CLEAR DATA	Complete, irretrievable deletion of all stored measured values
CLEAR BAT-DEF	Complete, irretrievable deletion of a battery database
QUIT	Return to the main menu

Measured Values

Select the → **DATA** → **SHOW DATA** function sequence from the **main menu** and press the **OK** key in order to open the **MEASUREMENTS** menu.

Table 20: Information on Stored **MEASUREMENTS**

Designation	Description
Measuring Function	Designation of the measuring function
[XXXXX]	Meaning varies depending on measurement: <ul style="list-style-type: none"> – Number of blocks over which measurements have been performed – Number of measurements (e.g. for INTERVAL U)
DD.MM.YY	Date of measurement
HH:MM:SS	Time of measurement
AN:XXXX	Location number assigned to the battery system
BN:XXXX	Battery number assigned to the battery

Navigate through all of the measurements in the **MEASUREMENT VALUES** menu using the ▼ ▲ keys. After selecting a given measurement and pressing the **OK** key, measured values and measured value details are displayed.

Note

If an RFID tag has been assigned to a system and the tag is read before measurement, the RFID tag's number is displayed instead of the AN and BN numbers in the corresponding measured values / measured value details.

Table 21: Measured **FLOAT** Values

Designation	Description
BLOCK	Measurement over one block
XXXX/X	Battery number / number of blocks
X.XXXX V	Measured voltage value
AN:XXXX	Location number assigned to the battery system
BN:XXXX	Battery number assigned to the battery

Table 22: Measured **DISCHARGE** and **CHARGE** Values

Designation	Description
BLOCK	Measurement over one block
XXXX/X	Battery number / number of blocks
X.XXXX V	Measured voltage value

Designation	Description
AN:XXXX	Location number assigned to the battery system
BN:XXXX	Battery number assigned to the battery

Table 23: Measured **RESISTANCE** Values

Designation	Description
BLOCK	Measurement over one block
XXXX/X	Battery number / number of blocks
XX.XXXX V	Measured voltage value
R(el) =	Measured value of the internal electrical resistance of a block
R(ct) =	Measured value of the internal electrochemical resistance of a block

Table 24: Measured **TEMPERATURE** Values

Designation	Description
BLOCK	Measurement over one block
XXXX/X	Battery number / number of blocks
XXXX.X C	Measured temperature value
AN:XXXX	Location number assigned to the battery system
BN:XXXX	Battery number assigned to the battery

Table 25: Measured **CONNECTOR** Values

Designation	Description
BLOCK	Measurement over one block
XXXX/X	Battery number / number of blocks
XXXX.XX mV	Measured voltage value
AN:XXXX	Location number assigned to the battery system
BN:XXXX	Battery number assigned to the battery

Table 26: Measured **INTERVAL U** Values

Designation	Description
COUNT:	Number of measurements performed over a freely defined time interval
X.XXX V	Display of overall battery voltage which was measured during a freely defined time interval
TIME.	Time interval during which the battery's overall voltage was measured

Table 27: Measured **INTERVAL U + I** Values

Designation	Description
COUNT:	Number of measurements performed
X.XXX V	Overall battery voltage measured during the defined time interval
X.XXXX A	Battery current measured during the defined time interval
TIME.	Time interval during which the battery's overall voltage and battery current were measured

Table 28: Measured **DMA (IrDA)** and **DMA35 (BT)** Values

Designation	Description
BLOCK	Measurement over one block
XXXX/X	Battery number / number of blocks
X.XXX kg/l	Acid density
X.XXX C	Temperature

Designation	Description
AN:XXXX	Location number assigned to the battery system
BN:XXXX	Battery number assigned to the battery

Menu for the Display of Measured Value Evaluations

In addition to individual measurements, measured value evaluations can also be displayed. Select a measurement in the **SHOW DATA** menu using the **▼ ▲** keys. Then press and hold the **OK** key until the menu with the measured value evaluations is displayed. Complete information is available in the section on "Viewing, Editing, Transferring and Evaluating Measured Values" → 50.

Table 29: Measured Value Evaluations

Designation	Description
SUM: [XXXX]	Sum of all measured values measured over the blocks of a battery. The number of blocks over which measurement has been performed is shown in square brackets (e.g. for FLOAT or RESISTANCE).
NUMBER [XXXX]	Number of all measured values that were measured during a multiple measurement over a block. The number of measurements is shown in square brackets (e.g. for TEMPERATURE).
AVER.:	Mean value of the measured values measured either over all blocks of a battery or over one block in the case of a multiple measurement.
MIN: XXXX	Smallest measured value of the measurement with indication of the number of the block at which the measured value was measured.
MAX: XXXX	Largest measured value of the measurement with indication of the number of the block at which the measured value was measured.

7.5 The SETTINGS Menu

Select **→ SETTINGS** in the **main menu** and then press the **OK** key in order to open the menu.

Table 30: SETTINGS Menu Functions

Function	Description
SYSTEM	System settings
MEASUREMENTS	Settings for measured value recording
BT-SETTINGS	Settings for Bluetooth® connection
CSV EXPORT	Settings for the transmission of data and measured values as a CSV file
SERVICE MENU	This function is for service only (⇒ "Service and Support" 53). Access is restricted by means of a password.
QUIT	Exit the SETTINGS menu and return to the main menu .

SYSTEM

Select the **→ SETTINGS → SYSTEM** function sequence from the **main menu** and press the **OK** key in order to open the **SYSTEM** menu.

Table 31: Functions in the SYSTEM Menu

Function	Description
SET TIME&DATE	Settings for device date and time
SEL. LANGUAGE	User language selection
TEST HEADSET	Playback of a test signal at a headset in order to check the Bluetooth® function
QUIT	Return to SETTINGS menu

MEASUREMENTS

Select the **→ SETTINGS → MEASUREMENTS** function sequence from the **main menu** and press the **OK** key in order to open the **MEASUREMENTS** menu.

Table 32: List of Functions Available in the MEASUREMENTS Menu

Function	Description
POLARITY ON	Switch polarity on: the negative or positive measured value is displayed.
POLARITY OFF	Switch polarity off: the absolute value of the measured value is displayed.
QUIT	Return to SETTINGS menu

BT-SETTINGS

Select the **→ SETTINGS → BT SETTING** function sequence from the **main menu** and press the **OK** key in order to open the **BT SETTINGS** menu.

Table 33: Functions in the BT SETTINGS Menu.

Function	Description
LINK COMPUTER	Function for establishing a Bluetooth® connection between the battery tester and a PC
LINK HEADSET	Function for establishing a Bluetooth® connection between the battery tester and a headset
LINK DMA35 V4	Function for establishing a Bluetooth® connection between the battery tester and a version 4 DMA 35 density meter from Anton Paar GmbH
REM. PAIRINGS	Termination of the Bluetooth® connection to all paired devices (device connections cannot be terminated individually)
QUIT	Return to SETTINGS menu

CSV EXPORT

Select the **→ SETTINGS → CSV EXPORT** function sequence from the **main menu** and press the **OK** key in order to open the **CSV EXPORT** menu.

Table 34: Functions in the CSV EXPORT Menu

Function	Description
EXPORT TARGET	Selection of the destination (e.g. PC) for the transmission of measured values as a CSV file (a Bluetooth® connection must first be established between the battery tester and the PC)
FILENA. FIXED	Function for defining a uniform filename when transferring measured values to a PC as a CSV file The file is named "BTPRO_Export.csv".
FILEN. UNIQ.	Function for generating different filenames each time measured values are transferred to a PC as a CSV file The file is named "BT-PRO_Export_<System-ID>_<Date>_<Time>.csv".
QUIT	Return to SETTINGS menu

7.6 INFO Menu

Select → **INFO** in the **main menu** and then press the **OK** key in order to open the menu.

Table 35: Information in the **INFO** Menu

Function	Description
VERSION:	The battery tester's current firmware version
ENTRIES:	Display of memory occupancy for measuring procedures as a percentage 100% = full storage capacity available 0% = no storage capacity available
MEMORY:	Display of memory occupancy for measured values as a percentage 100% = full storage capacity available 0% = no storage capacity available
BATTERY	Battery charge status (in volts)

8 “BT PRO Manager” PC Software

“BT PRO Manager” PC software is an important tool when using the battery tester. The program can be used to:

- Create, maintain and manage the battery database (DUT management)
- Transfer and save measurement data
- View measurement results and create measurement evaluations (reports)

Note

We strongly recommend using BT PRO Manager software! The battery tester can be used without the software, but in this case the important and convenient functions listed above are unavailable.

This section provides you with all the information you’ll need to work with BT PRO Manager.

When working with the battery tester and BT PRO Manager for the first time, begin by following the instructions included in the sections up through “Creating the Battery Database” in the order in which they appear.

If you’ve already performed measurements and would like to import the measurement data into BT PRO Manager, as well as view and create reports, go directly to ⇒ “Importing Measurement Data”  24.

8.1 Installation, Launching the Program and Update

Download

The current version of the software can be downloaded free of charge as a ZIP file from the “myGMC” service portal on GMC-I’s website:



<http://www.gmc-instruments.de/services/mygmc/>

First of all, you’ll have to register yourself and your test instrument. You’re then provided with access to the download.

System Requirements

- PC with Microsoft Windows 7® or higher
- Screen resolution of at least 1024 × 768
- At least 2 GB available hard disk memory
- At least 8 GB RAM

Installation

- ✓ You’ve already downloaded the installation file ⇒  18.
- ✓ Your system fulfills the specified requirements ⇒  18.

1. Run the installation file.
The installation wizard appears.
2. Follow the instructions displayed by the installation wizard.
↳ The software is installed on your PC.

Launching the Program

✓ BT PRO Manager has been installed on your PC ⇒  18.
The program can be launched by means of the usual Windows® procedures, e.g. by using the desktop shortcut.

Update

Software updates provide new features and bug fixes.

All settings, measurement data and the battery database are retained when the software is updated.

1. Check to see which software version is currently available ⇒ “Download”  18.
2. Start BT PRO Manager.
The **Login** dialog appears.
3. Click the **X** button.
The Login dialog is closed.
4. Click the **Information** button.
The **Information** dialog appears and displays the currently installed software version.

5. Compare the software versions.
 - If the versions differ: continue.
 - If the versions are identical: no action is required.
6. Download the latest version of the software.
7. Run the installation file.
The installation wizard appears.
8. Follow the instructions displayed by the installation wizard.
↳ The software is updated.

8.2 Overview

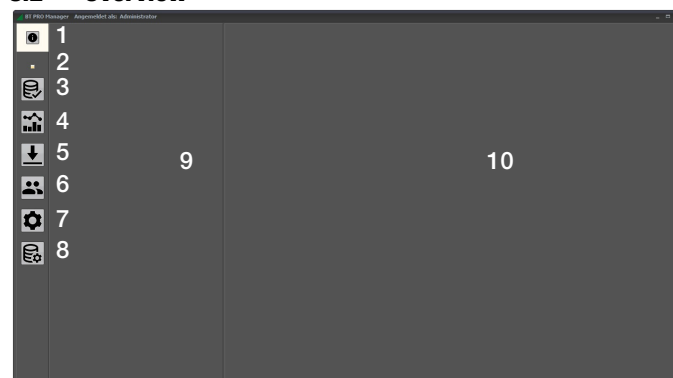

No. Meaning

- | | |
|----|---|
| 1 | Information
Shows information about the program. |
| 2 | Database status |
| 3 | Definitions
Defines batteries including all associated information such as blocks and location |
| 4 | Display measurement series
Displays data associated with already performed measurements |
| 5 | Read in measurement series
Reads in measurement data from the battery tester or from a stored CSV file |
| 6 | User administration
Defines user accounts for login |
| 7 | General settings
Defines general settings |
| 8 | Database settings
Defines settings for the database |
| 9 | Display selection
Elements can be selected here for which further information is displayed in the detail display area (10). |
| 10 | Detail display area
Displays detailed information about the element selected in the display selection (9). Some of this information can be edited or deleted. |

8.3 Defining the Data(base) Storage Location

All data (measurement data, battery databases etc.) available in BT PRO Manager are stored in a database.

Access is protected with the help of user accounts ⇒  19.

This database can be stored locally at a PC or remotely on a server. The main difference between local and server-based databases is the number of user accounts: you can set up as many as 10 user accounts for a local database. Only one administrator can be set up for a server database.

If necessary, you can create several databases and switch amongst them. As a service provider, for example, you can create separate databases for each customer.

A local database is created when BT PRO Manager is installed. This is selected by default and can be used immediately.

Using the Local Database

During program installation, an empty local database is created which is included in BT PRO Manager by default. Alternatively, you can select a different local database.

- ✓ The database is located on the PC where BT PRO Manager is installed.
 - ✓ The database uses the “.fdb” format.
 - ✓ You know the username and password for the database.
1. Start BT PRO Manager.
The **Login** dialog appears.
 2. Click the **X** button.
The Login dialog is closed.
 3. Click the **Database Settings** button.
The **Database** dialog appears.
 4. Activate the **Local** checkbox.
 5. Enter the path to the database in the **Database** field.
 6. Click the **Save** button.
The setting is saved. The program is exited.
 7. Start BT PRO Manager.
The **Login** dialog appears.
 8. Log in.
- ↳ The other database is integrated and can be used.

Using a Server Database

- ✓ The database is located on a server.
 - ✓ The database uses the “.fdb” format.
 - ✓ You know the username and password for the database.
 - ✓ There's a network connection between the PC with BT PRO Manager and the server.
1. Start BT PRO Manager.
The **Login** dialog appears.
 2. Click the **X** button.
The Login dialog is closed.
 3. Click the **Database Settings** button.
The **Database** dialog appears.
 4. Activate the **Server** checkbox.
 5. Enter the path to the database in the **Alias** field.
 6. Enter the server's IP address to the **Server** field.
 7. Enter the number of the port by means of which connection is established to the **Port** field.



Note

The port must not be blocked by a firewall or other security measure.

8. Enter the user name for accessing the database to the **User** field.
 9. Enter the password for accessing the database to the **Password** field.
 10. Click the **Save** button.
The setting is saved. The program is exited.
- ↳ The other database is integrated and can be used the next time the program is started.

Querying Database Status

If connection to the database is interrupted, a message appears automatically. However, the status of the database can be queried manually as well.

- ✓ BT PRO Manager has been installed on your PC ⇨ 18.
1. Start BT PRO Manager.
 2. Click the database status box.
The **Information** dialog appears.
- ↳ The database status is displayed.
If necessary, follow the instructions in the dialog to restore an interrupted connection.

8.4 Managing User Accounts

BT PRO is equipped with a user administration feature. None of the important functions can be used until after logging in.

User accounts are database-specific, i.e. their validity depends on the integrated database (⇨ 18). However, user accounts are managed via the program and BT PRO Manager sets up the user accounts for the respective database.

When the program is started for the first time, an administrator account is automatically created for the empty, local database which is installed along with the program. After specifying a password for this account, you can set up and manage additional user accounts with various rights.

Specifying The Administrator Password (first program start)

The administrator account is created automatically the first time the program is started. You can specify the password.

- ✓ BT PRO Manager has been installed on your PC ⇨ 18.
1. Start BT PRO Manager.
The **Information** dialog appears. An “admin” user account is created.
 2. Click the **OK** button.
The **Login** dialog appears.
 3. Enter **admin** to the **user name** field.
 4. Enter any desired password with at least 8 characters to the **Password** field.
 5. Click the ✓ button.
Your password is saved and is displayed again for confirmation.
The **Login** dialog appears.
 6. Log in using the **admin** user account and your password.
- ↳ You're logged in and can now use the program. Create additional user accounts if required.

Creating User Accounts

In addition to the administrator account, you can create 9 further user accounts (total: 10) with different rights for local databases. Functions for which no rights are available are not displayed in the account window.



Note

No further user accounts can be created for server databases.

First create a user account. The password is specified the first time you log in via the user account.

- ✓ BT PRO Manager has been installed on your PC ⇨ 18.
 - ✓ The administrator account has been created ⇨ 19.
1. Start BT PRO Manager.
The **Login** dialog appears.
 2. Log in as administrator.
 3. Click the **User Administration** button.
The **User Administration** dialog appears.
 4. Click the + button.
 5. Enter a designation to the **user name** field.
(Enter a full user name as it should appear in the report ⇨ “Viewing Measurement Series and Creating Measurement Evaluations (reports)” 25. The login name is defined during the next step.)
 6. Enter the login name to the **login name** field.
(The login name is used to log in to the program. For example, initials can be used to save time when logging in.)
 7. Select a role profile with predefined rights from the **Presets** list. Alternatively, you can select any desired rights from the **Function, Administrator, Action, Definitions** and **Reports** areas by entering checkmarks.
 8. Enter the user's e-mail address of to the **e-mail** field.
The e-mail address appears in reports ⇨ “Viewing Measurement Series and Creating Measurement Evaluations (reports)” 25.
 9. Click the ✓ button.
The user account is created.

10. Exit BT PRO.
 11. Start BT PRO Manager.
The **Login** dialog appears.
 12. Enter the previously specified login name to the **user name** field.
 13. Enter any desired password with at least 8 characters to the **Password** field.
 14. Click the ✓ button.
 15. Enter the password again.
 16. Click the ✓ button.
The password is saved.
- ↳ The administrator account is created.

Editing User Accounts

You can edit user accounts, for example by assigning different rights. The password cannot be changed.

A user account with user administration rights is required in order to edit user accounts. For example, you can use the administrator account.

- ✓ BT PRO Manager has been installed on your PC ⇨ 18.
- ✓ The user account has user administration rights.

1. Start BT PRO Manager.
The **Login** dialog appears.
 2. Log in via a user account with user administration rights, for example the administrator account.
 3. Click the **User Administration** button.
The **User Administration** dialog appears.
 4. Select the desired user account from the **User Name** list.
 5. Click the ✎ button.
The editing mode is active.
 6. Make the desired changes.
 7. Click the ✓ button.
- ↳ The user account is edited.

Deleting a User Account

You can delete a previously created user account. The administrator account cannot be deleted.

A user account with user administration rights is required in order to delete a user account. For example, you can use the administrator account.

1. Start BT PRO Manager.
The **Login** dialog appears.
 2. Log in via a user account with user administration rights, for example the administrator account.
 3. Click the **User Administration** button.
The **User Administration** dialog appears.
 4. Select the desired user account from the **User Name** list.
 5. Click the – button.
A security prompt appears.
 6. Acknowledge the security prompt by clicking **Yes**.
- ↳ The user account is deleted.

Password Forgotten

If you forget the password for a user account, delete the user account (⇨ 20) and create a new one (⇨ 19).

If you forget the password for the administrator account and you don't have another user account with administrator rights, please contact ⇨ "Product Support" 53.

8.5 Basic Setting: Specifying the Temperature Unit of Measure

Temperature values can be displayed in degrees Celsius (°C) or Fahrenheit (°F). The default setting is degrees Celsius (°C).

1. Start BT PRO Manager.
 2. Click the **General Settings** button.
The **General Settings** dialog appears.
 3. Deactivate or activate the **Fahrenheit** checkbox.
 4. Click the **Accept** button.
- ↳ The setting is saved.

8.6 Creating and Managing the Battery Database

Many battery systems are complex and their objects require inventory management. Inspecting the system involves all sorts of maintenance and service work, for which measurements are required. These measurements must be correctly assigned to the respective object. This is the case regardless of whether you're managing your own system or customer systems as a service provider.

The location of the battery system, the battery itself, the number of blocks in the battery and the limit values must be defined for measurements (⇨ 18) performed with the battery tester (except **MULTIMETER**). This makes it possible to evaluate the measurement in an object-specific manner (type-dependent limit values etc.), and assign it correctly to the object.

Manually entering the measurement parameters and manual transfer of the obtained measured values to your documents is of course inconvenient, error-prone and very time-consuming.

In order to avoid this, a battery database can be created in BT PRO Manager software. This makes it possible to visualize all of your DUTs within a single digital structure. The battery database must be kept up to date continuously, for example when replacing units. The battery database is transferred to the battery tester after it's created, and each time it's changed.

Select the entry associated with the device under test from the database on-site before starting the measurement. This assigns the measured value to the respective object. After all measurements have been completed, transfer the results to BT PRO Manager for review and evaluation (⇨ "Viewing Measurement Series and Creating Measurement Evaluations (reports)" 25).

If you or your customers use an RFID system for asset management whose tags (transponders) operate at a frequency of 125 kHz, this can be taken advantage of. Instead of manually selecting the entry for the DUT from the database, just scan the RFID tag and the entry is selected automatically. The RFID tags must first be linked (one time only) to the respective DUTs in the database after creating the database to this end ⇨ 24.

In order to be able to digitally map a system as an accurate replication of the original, various entries are created and linked to each other at different levels:

- The battery is the central unit (device under test).
- Block type (⇨ 22) and location (⇨ 22) are assigned to the battery.
- Block technology (⇨ 21) and manufacturer (⇨ 22) are assigned in turn to each block type.

These 4 entries must be furnished with all relevant information, for example the limit values required for the measurement.

Due to this linking, we recommend that you start at the lowest level and work your way up.

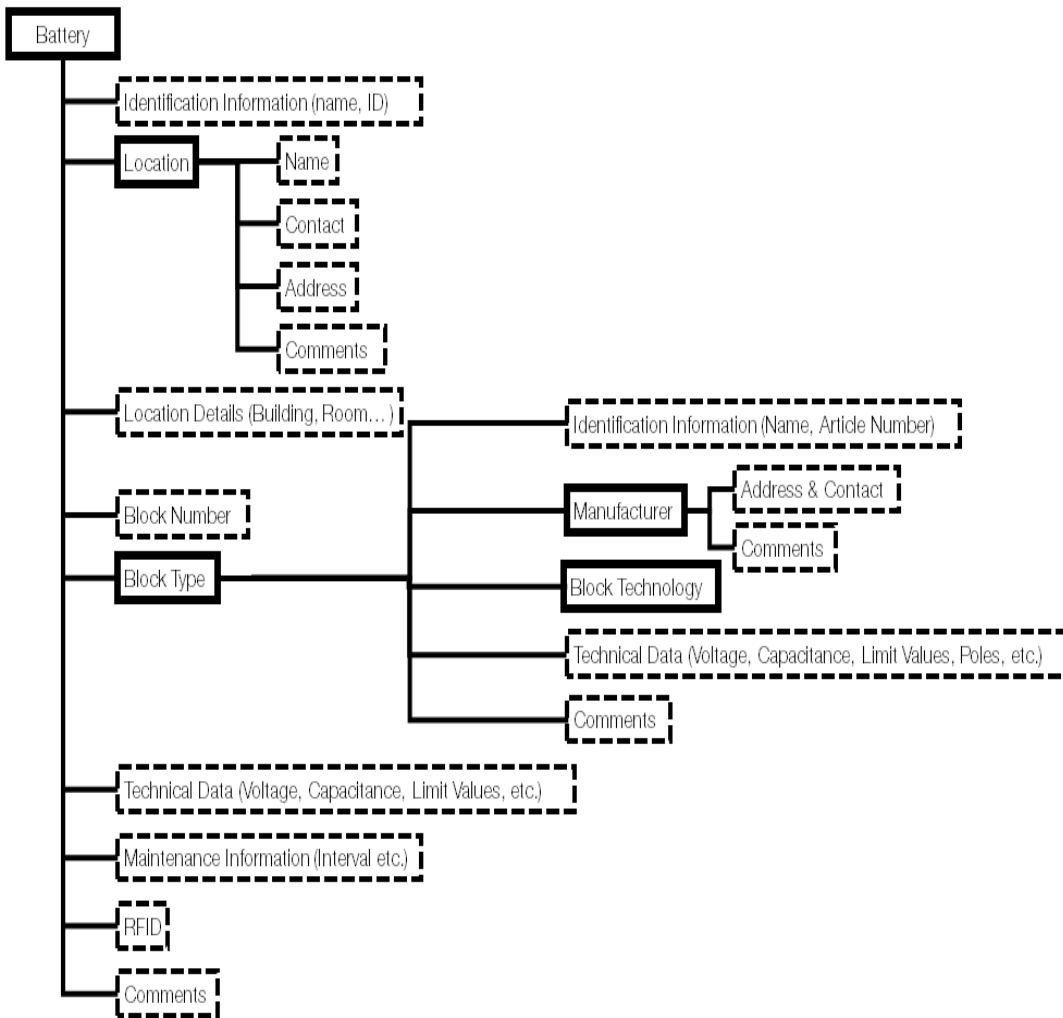

Figure 6: Database Structure – Entries (——) and Storable Information (-----)

Entering Block Technologies

Defines a block technology which is assigned to a block type.

1. Start BT PRO Manager.
2. Click the **Definitions** button.
The **Definitions** menu appears in the **display selection**.
3. Select **Block Technology** from the list.
The fields for defining the block technology are displayed in the **detail display area**.
4. Click the + button.
The fields are ready for input.
5. Define the block technology parameters.
Example: Lithium
(Yellow fields must be filled in. Permissible entries: A to Z, a to z and 0 to 9.)
6. Click the ✓ button.
↳ The block technology is stored.

Editing Block Technologies

✓ A block technology has been entered.

1. Start BT PRO Manager.
2. Click the **Definitions** button.
The **Definitions** menu appears in the **display selection**.
3. Select **Block Technology** from the list.
Previously entered **block technologies** appear in the **display selection**.

4. Click the block technology you want to edit.
The fields for defining the block technology are displayed in the **detail display area**.
5. Click the ✎ button.
The fields are ready for input.
6. Change the desired block technology parameters.
(permissible entries: A to Z, a to z and 0 to 9.)
7. Click the ✓ button.
↳ The block technology is edited.

Deleting a Block Technology

✓ A block technology has been entered.
✓ The block technology is not assigned to any block type.

1. Start BT PRO Manager.
2. Click the **Definitions** button.
The **Definitions** menu appears in the **display selection**.
3. Select **Block Technology** from the list.
Previously entered block technologies appear in the **display selection**.
4. Click the block technology you want to delete.
The fields for defining the block technology are displayed in the **detail display area**.
5. Click the – button.
A security prompt is displayed.
6. Acknowledge the security prompt.
↳ The block technology is deleted.

Entering Manufacturers

Defines a manufacturer which is assigned to a block type.

1. Start BT PRO Manager.
2. Click the **Definitions** button.
The **Definitions** menu appears in the **display selection**.
3. Select **Manufacturer** from the list.
The fields for defining the manufacturer are displayed in the **detail display area**.
4. Click the + button.
The fields are ready for input.
5. Define the manufacturer parameters.
(Yellow fields must be filled in. Permissible entries: A to Z, a to z and 0 to 9.)
6. Click the ✓ button.
↳ The manufacturer is stored.

Editing Manufacturers

- ✓ A manufacturer has been entered.
1. Start BT PRO Manager.
 2. Click the **Definitions** button.
The **Definitions** menu appears in the **display selection**.
 3. Select **Manufacturer** from the list.
Previously entered **manufacturers** appear in the **display selection**.
 4. Click the manufacturer you want to edit.
The fields for defining the manufacturer are displayed in the **detail display area**.
 5. Click the ✎ button.
The fields are ready for input.
 6. Change the desired manufacturer parameters.
(permissible entries: A to Z, a to z and 0 to 9.)
 7. Click the ✓ button.
↳ The manufacturer is edited.

Deleting Manufacturers

- ✓ A manufacturer has been entered.
 - ✓ The manufacturer is not assigned to any block type.
1. Start BT PRO Manager.
 2. Click the **Definitions** button.
The **Definitions** menu appears in the **display selection**.
 3. Select **Manufacturer** from the list.
Previously entered manufacturers appear in the **display selection**.
 4. Click the manufacturer you want to delete.
The fields for defining the manufacturer are displayed in the **detail display area**.
 5. Click the – button.
A security prompt is displayed.
 6. Acknowledge the security prompt.
↳ The manufacturer is deleted.

Entering a Block Type

Defines a block type which is assigned to batteries.

- ✓ A block technology has been entered ⇨ 21.
 - ✓ A manufacturer has been entered ⇨ 22.
1. Start BT PRO Manager.
 2. Click the **Definitions** button.
The **Definitions** menu appears in the **display selection**.
 3. Select **Block Type** from the list.
The fields for defining the block type are displayed in the **detail display area**.
 4. Click the + button.
The fields are ready for input.
 5. Define the block type parameters. Enter the previously defined block technology and the manufacturer.



Note

Some block-specific values are used for batteries as well (⇨ 23) and linked to other values.

- (Yellow fields must be filled in. Permissible entries: A to Z, a to z and 0 to 9.)
6. Click the ✓ button.
↳ The block type is stored.

Editing a Block Type

- ✓ A block type has been entered.
 - ✓ A block technology has been entered.
 - ✓ A manufacturer has been entered.
1. Start BT PRO Manager.
 2. Click the **Definitions** button.
The **Definitions** menu appears in the **display selection**.
 3. Select **Block Type** from the list.
Previously entered block types appear in the **display selection**.
 4. Click the block type you want to edit.
The fields for defining the block type are displayed in the **detail display area**.
 5. Click the ✎ button.
The fields are ready for input.
 6. Change the desired block type parameters.
(permissible entries: A to Z, a to z and 0 to 9.)
 7. Click the ✓ button.
↳ The block type is edited.

Deleting a Block Type

- ✓ A block type has been entered.
 - ✓ The block type is not assigned to any batteries.
1. Start BT PRO Manager.
 2. Click the **Definitions** button.
The **Definitions** menu appears in the **display selection**.
 3. Select **Block Type** from the list.
Previously entered block types appear in the **display selection**.
 4. Click the block type you want to delete.
The fields for defining the block type are displayed in the **detail display area**.
 5. Click the – button.
A security prompt is displayed.
 6. Acknowledge the security prompt.
↳ The block type is deleted.

Entering a Location

Defines a location which is assigned to batteries.



1. Start BT PRO Manager.
2. Click the **Definitions** button.
The **Definitions** menu appears in the **display selection**.
3. Select **Location** from the list.
The fields for defining the location are displayed in the **detail display area**.
4. Click the + button.
The fields are ready for input.
5. Define the location parameters.
(Yellow fields must be filled in. Permissible entries: A to Z, a to z and 0 to 9.)
6. Click the ✓ button.
↳ The location is stored.



Note

The values entered here are mandatory because they're used for measurements. They're block-specific. Enter all values, i.e. limit values, nominal values etc.

Editing Locations



- ✓ A location has been entered.
- 1. Start BT PRO Manager.
- 2. Click the **Definitions** button.
The **Definitions** menu appears in the **display selection**.
- 3. Select **Location** from the list.
Previously entered locations appear in the **display selection**.
- 4. Click the location you want to edit.
The fields for defining the location are displayed in the **detail display area**.
- 5. Click the  button.
The fields are ready for input.
- 6. Change the desired location parameters.
(permissible entries: A to Z, a to z and 0 to 9.)
- 7. Click the  button.
- ↳ The location is edited.

Deleting a Location

- ✓ A location has been entered.
- ✓ The location is not assigned to any batteries.
- 1. Start BT PRO Manager.
- 2. Click the **Definitions** button.
The **Definitions** menu appears in the **display selection**.
- 3. Select **Location** from the list.
Previously entered locations appear in the **display selection**.
- 4. Click the location you want to delete.
The fields for defining the location are displayed in the **detail display area**.
- 5. Click the – button.
A security prompt is displayed.
- 6. Acknowledge the security prompt.
- ↳ The location is deleted.

Entering a Battery (DUT)

Defines a battery (device under test). If you only want to measure one block, enter a battery with just one block.

- ✓ A location has been entered ⇔  22.
- ✓ A block type has been entered ⇔  22.
- 1. Start BT PRO Manager.
- 2. Click the **Definitions** button.
The **Definitions** menu appears in the **display selection**.
- 3. Select **Battery** from the list.
The fields for defining the battery are displayed in the **detail display area**.
- 4. Click the + button.
The fields are ready for input.
- 5. Define the battery parameters. Enter the previously defined location and block types.



Note

The values entered here are mandatory because they're used for measurements. Enter all values, i.e. limit values, nominal values etc.



Note



Some values are taken from the block-specific values (⇔ "Entering a Block Type"  22), linked to other values and applied to the battery.

(Yellow fields must be filled in. Permissible entries: A to Z, a to z and 0 to 9.)

- 6. Click the  button.
- ↳ The battery is stored.

Editing a Battery

- ✓ A battery has been entered.
- 1. Start BT PRO Manager.
- 2. Click the **Definitions** button.
The **Definitions** menu appears in the **display selection**.

- 3. Select **Battery** from the list.
Previously entered locations appear in the **display selection**.
- 4. Click the battery you want to edit.
The fields for defining the battery are displayed in the **detail display area**.
- 5. Click the  button.
The fields are ready for input.
- 6. Change the desired battery parameters.
(permissible entries: A to Z, a to z and 0 to 9.)
- 7. Click the  button.
- ↳ The battery is edited.

Deleting a Battery

- ✓ A battery has been entered.
- 1. Start BT PRO Manager.
- 2. Click the **Definitions** button.
The **Definitions** menu appears in the **display selection**.
- 3. Select **Battery** from the list.
Previously entered batteries appear in the **display selection**.
- 4. Click the battery you want to delete.
The fields for defining the battery are displayed in the **detail display area**.
- 5. Click the – button.
A security prompt is displayed.
- 6. Acknowledge the security prompt.
- ↳ The battery is deleted.

8.7 Transferring the Battery Database to the Battery Tester

A Bluetooth® connection must be established between the PC and the battery tester before transferring the battery database to the battery tester. It must be assured that the COM port in the operating system and in BT PRO Manager match up with each other.

The following instructions are provided as an example for a PC running Microsoft® Windows® 10. The procedure is similar for all other Microsoft® Windows® operating systems.

- ✓ The battery database has been defined ⇔  30.
- 1. Open the Windows® start menu.
- 2. Click "Settings".
The **Windows Settings** dialog opens.
- 3. Click the **Devices** button.
The **Devices** dialog appears with the **Bluetooth & other devices** window.
- 4. Select → **SETTINGS** from the **main menu** at the battery tester using the ▼ ▲ keys.
- 5. Press the **OK** key.
The **SETTINGS** menu is displayed.
- 6. Select → **BT SETTINGS** using the ▼ ▲ keys.
- 7. Press the **OK** key.
The **BT SETTINGS** menu is displayed.
- 8. Select → **LINK COMPUTER** using the ▼ ▲ keys.
- 9. Press the **OK** key.
BT PAIRING: WAITING FOR PC is displayed.
- 10. In Windows®, click the **Add Bluetooth or other device** button in the **Add Bluetooth & other devices** dialog.
The **Add a device** dialog appears.
- 11. Click the **Bluetooth** button.
The system searches for Bluetooth® devices. After some time, the battery tester appears.
- 12. Click the battery tester.
Connection is established. The **CODE CORRECT?** message and a six-digit number appear at the battery tester. Information concerning the connection and a six-digit number are displayed at the PC.
- 13. Compare the six-digit numbers.
- 14. If the six-digit numbers are identical, press the **OK button** on the battery tester.

15. Click the **Connect** button in the **Add a device** dialog in Windows®. Connection is established. The following message appears at the battery tester: **COMPUTER PAIRED? CONTINUE WITH KEY!**. The connection process is displayed at the PC, and finally a message indicating successful connection appears.
16. Click **Done** in the **Add a device** dialog in Windows®. The devices are connected.
17. Open the Windows® start menu.
18. Click **Settings**. The Windows Settings dialog opens.
19. Click the **Devices** button. The Devices dialog appears with the **Bluetooth & other devices** window.
20. Click **More Bluetooth options** in the list on the right. The **Bluetooth Settings** dialog is displayed.
21. Click the **COM Ports** tab. The **COM Ports** tab is displayed.
22. Search the list for the port named **BTPRO** with the **Outgoing** direction. Make a note of the port number.
23. Start BT PRO Manager.
24. Click the **General Settings** button. The **General Settings** dialog appears.
25. Make sure that the number in the **COM Port** field matches the COM port number you previously made a note of.
 - If they match, go to step 27.
 - If they don't match, enter the COM port number to the **COM Port** field and click the **Accept** button. The setting is saved.
26. Close the **General Settings** dialog by clicking the **X** button.
27. Click the **Definitions** button. The **Definitions** area appears in the **display selection**.
28. Select **Battery** from the list. Previously entered batteries appear in the **display selection**. Optional: If you only want to transfer part of the battery database, follow steps 20 to 24. Otherwise go to step 25.
29. Click the **≡** icon. The **Filter** dialog appears.
30. Activate the desired filter by activating the checkbox.
31. Define the filter criterion in the field.
32. Click **Apply**. The battery database is filtered.
33. Close the **Filter dialog**.
34. Click **↑** under the **display selection**. The **Transfer Battery Definitions** dialog is displayed.
35. Click the **Transfer** button.
 - ↳ The battery database is transferred to the battery tester and can be used for measurements (⇒ 18).

8.8 Assigning RFID Tags to Batteries (DUTs)

Battery parameters, such as the battery identification number, are required for measurements.

If you manage your system components with RFID technology, you can take advantage of this during on-site measurement to assign the performed measurement to a device under test.

Simply scan the RFID tag attached to the actual DUT with the battery tester's RFID reader during measurement (⇒ 5). The corresponding digital DUT (battery) is automatically selected from the battery database.

However, the RFID tags must first be linked to the database's respective DUTs after creating the battery database. The RFID tag must be scanned and assigned to this end – direct manual entry to the database in BT PRO Manager isn't possible.

You can tell whether or not a DUT is already linked to an RFID tag by looking at the bottom right-hand corner of the DUT's entry:

- -- = no RFID tag assignment
- RF = RFID tag assigned

- ✓ You've created a battery database which includes all devices under test ⇒ "Creating and Managing the Battery Database" 20.
- ✓ The battery database has been transferred to the battery tester ⇒ 23.
- ✓ The system's objects are equipped with RFID tags.
 1. Switch the battery tester on ⇒ 7.
 2. Press the **OK** key. The **main menu** appears.
 3. Select **→ DATA MENU** from the **main menu** using the **▼ ▲** keys.
 4. Press the **OK** key. The **DATA MENU** menu is displayed.
 5. Select **→ SHOW BATT-DEF** in the **DATA MENU** menu using the **▼ ▲** keys.
 6. Press the **OK** key. The battery database appears which was previously loaded to the device.
 7. Select the desired battery. (Batteries without RFID assignment can be recognized by the -- entry in the lower right corner.)
 8. Press and hold the **OK** key. An acoustic signal indicates that the RFID reader is ready. --- --> () <----- appears at the display.
 9. Hold the battery tester with its display roughly 1 to 2 cm above the RFID tag. The battery tester reads the RFID tag. A brief acoustic signal acknowledges recognition. The battery entry is displayed and **RF** appears at the bottom right.
 - ↳ The RFID tag is assigned to the battery. If you read the RFID tag during a measurement, the measurement data are assigned to the battery.

8.9 Importing Measurement Data

There are two ways to import measurement data to BT PRO Manager:

1. Connect the battery tester to the PC and read out the data.
2. Import an existing CSV file (⇒ "Saving Measured Values to a PC (data backup)" 50).

Connecting BT PRO Manager to the PC and Reading Out Data

First of all, the battery tester is connected to the PC via Bluetooth®. It must be assured that the COM port in the operating system and in BT PRO Manager match up with each other. The data are then read in from the battery tester to BT PRO Manager. The data are also saved as an export file.

The following instructions are provided as an example for a PC running Microsoft® Windows® 10. The procedure is similar for all other Microsoft® Windows® operating systems.

- ✓ A COM port (outgoing direction) on the PC is used for connection under Windows®. Read the documentation included with your operating system for detailed information.
- ✓ The COM port on the PC and the COM port in BT PRO Manager have the same number. (If not, refer to ⇒ "Viewing Measurement Series and Creating Measurement Evaluations (reports)" 25.)
 1. Open the Windows® start menu.
 2. Click "Settings". The **Windows Settings** dialog opens.
 3. Click the **Devices** button. The **Devices** dialog appears with the **Bluetooth & other devices** window.
 4. Select **→ SETTINGS** from the **main menu** at the battery tester using the **▼ ▲** keys.
 5. Press the **OK** key. The **SETTINGS** menu is displayed.
 6. Select **→ BT-SETTINGS** using the **▼ ▲** keys.
 7. Press the **OK** key. The **BT SETTINGS** menu is displayed.
 8. Select **→ LINK COMPUTER** using the **▼ ▲** keys.

9. Press the **OK** key.
BT PAIRING: WAITING FOR PC is displayed.
10. In Windows[®], click the **Add Bluetooth or other device** button in the **Add Bluetooth & other devices** dialog.
The **Add a device** dialog appears.
11. Click the **Bluetooth** button.
The system searches for Bluetooth[®] devices. After some time, the battery tester appears.
12. Click the battery tester.
Connection is established. The **CODE CORRECT?** message and a six-digit number appear at the battery tester. Information concerning the connection and a six-digit number are displayed at the PC.
13. Compare the six-digit numbers.
14. If the six-digit numbers are identical, press the **OK** button on the battery tester.
15. Click the **Connect** button in the **Add a device** dialog in Windows[®].
Connection is established. The following message appears at the battery tester: **COMPUTER PAIRED? CONTINUE WITH KEY!**. The connection process is displayed at the PC, and finally a message indicating successful connection appears.
16. Click **Done** in the **Add a device** dialog in Windows[®].
The devices are connected.
17. Open the Windows[®] start menu.
18. Click **Settings**.
The Windows Settings dialog opens.
19. Click the **Devices** button.
The Devices dialog appears with the **Bluetooth & other devices** window.
20. Click **More Bluetooth options** in the list on the right.
The **Bluetooth Settings** dialog is displayed.
21. Click the **COM Ports** tab.
The **COM Ports** tab is displayed.
22. Search the list for the port named **BTPRO** with the **Outgoing** direction.
Make a note of the port number.
23. Start BT PRO Manager.
24. Click the **General Settings** button.
The **General Settings** dialog appears.
25. Make sure that the number in the **COM Port** field matches the COM port number you previously made a note of.
 - If they match, go to step 27.
 - If they don't match, enter the COM port number to the **COM Port** field and click the **Accept** button.
The setting is saved.
26. Close the **General Settings** dialog by clicking the **X** button.
27. Click the **Read in Measurement Series** button.
The **Read in Measurement Series** menu appears in the **display selection**.
28. Click the **BT PRO (read out)** button.
The dialog for saving the export file appears.
29. Select a directory path and a filename for the export file here.
30. Acknowledge your entry.
 - ↳ The data are read of the battery tester and imported into BT PRO Manager. Information appears at the detail display area (e.g. number of imported measurement series). A log file and a CSV file are also saved. The CSV file contains the measurement data and is intended as a backup copy. Store this file in a safe place in order to prevent data loss.

Reading In a CSV File

- ✓ The measurement data are available as a CSV file ⇨ "Saving Measured Values to a PC (data backup)" 49.
1. Start BT PRO Manager.
 2. Click the **Read in Data** button.
The **Read in Measurement Series** menu appears in the **display selection**.
 3. Click the **Read in Measurement Series** button.
The data entry dialog appears.
 4. Select the CSV file.
 5. Confirm that the file should be opened.

- ↳ The measurement data from the CSV file are imported. Information appears at the detail display area (e.g. number of imported measurement series). You can save this information as a log file. Click the **Report** button above the detail display area to this end.



8.10 Viewing Measurement Series and Creating Measurement Evaluations (reports)

BT PRO Manager software not only allows you to view and edit measurement data, you can also evaluate data in the form of reports.

Viewing Measurement Series

- ✓ Measurement data are available in BT PRO Manager ⇨ "Importing Measurement Data" 24.
1. Start BT PRO Manager.
 2. Click the **Display Measurement Series** button.
The **Measurements** menu appears in the **display selection**.
 3. Select the desired type of measurement from the list.
Depending on the selected list entry, the following appears in the **display selection**:
 - Folder view = locations and batteries
 - Most recent = all measurements in descending chronological order
 - Specific measuring function = all measurements of the selected type in descending chronological order
 The first measurement series is selected automatically. The measured values are displayed in the **detail display area**.
 4. Select the desired measurement series from the **Measurement Series Selection** list in the **display area**.
 - ↳ The measured values of the selected measurement series are displayed in tabular form in the **detail display area**.

Other display options:

- **Limit values:**
Depending on the measurement, lower and upper limit values are defined. If the values lie within the limits, they're displayed in green, if they're outside the limits, they're displayed in red. In order to change the limit values for the current evaluation, enter new values to the **Lower Limit Value** and **Upper Limit Value** fields and refresh the display by clicking . The evaluation is displayed with the corresponding changes, but the limit values are not changed permanently.
- **Type of display:**
The measurement series can be displayed in a different format. In order to change the display format, click the icon for another display type above the **detail display area**, e.g. bar chart  or history .
- **History** display:
The history display compares older measurement series (of the same type taken at the same location or in the same system) with the current series. You decide which measurement series you want to compare by unchecking the boxes in front of the unwanted measurements.
- **Excerpt:**
In some display modes you can select an excerpt, in which case only the measurement data contained in the excerpt is displayed.
In order to select an excerpt, click on the beginning of the desired excerpt in the report and hold the mouse button down. Drag the mouse pointer over the desired excerpt. A selection box appears. When you release the mouse button, the area included in the selection box is displayed in an enlarged format.

Note

You can print some of the selected displays as individual reports ⇨ "Individual Report: Creating and Printing an Individual Measurement Evaluation" 26.

Commenting Measurement Series

You can add a comment to each measurement series in order to make a note of additional information. If you create a report, it will include the comment.

- ✓ Measurement data are available in BT PRO Manager ⇨ “Importing Measurement Data” 24.
1. Start BT PRO Manager.
 2. Click the **Display Measurement Series** button.
The **Measurements** menu appears in the **display selection**.
 3. Select the desired type of measurement from the list.
The measurement series appear in the **display selection**.
The first measurement series is selected automatically.
The measured values are displayed in the **detail display area**.
 4. Select the desired measurement series from the **Measurement Series Selection** list in the **display area**.
The measured values of the selected measurement series are displayed in the **detail display area**.
 5. Click the  icon above the **detail display area**.
The **Measurement Series Comment** dialog appears.
 6. Enter your comment to the **Comment** field.
 7. Click the ✓ button.
- ↳ The comment is stored.

Deleting a Measurement Series

- ✓ Measurement data are available in BT PRO Manager ⇨ “Importing Measurement Data” 24.
1. Start BT PRO Manager.
 2. Click the **Display Measurement Series** button.
The **Measurements** menu appears in the **display selection**.
 3. Select the desired type of measurement from the list.
The measurement series appear in the **display selection**. The first measurement series is selected automatically.
The measured values are displayed in the **detail display area**.
 4. Select the desired measurement series from the **Measurement Series Selection** list in the **display area**.
 5. Click the – icon above the **detail display area**.
A security prompt appears.
 6. Acknowledge the security prompt by clicking **Yes**.
- ↳ The measurement series is deleted.

Individual Information in Reports



- Inspector’s name in reports:
The name of the user account with which the measurement data was entered to the database is automatically used in test reports as the inspector ⇨ “Importing Measurement Data” 24.
If **Created by** is selected, the user name of the user account used to create the report appears. Log in via the user account whose name should appear in the report.
 - Logos in reports:
A logo is displayed in the individual report (for the individual measurement evaluation) and the multiple report (for the multiple measurement evaluation). The BT PRO Manager logo appears by default.
You can replace this logo with your own graphic. It’s scaled automatically.
- ✓ Hidden folders are displayed on your Windows® system.
Read the documentation included with your operating system for detailed information.
 - ✓ Your graphic is a .jpg file.
1. Rename your graphic. The filename must read as follows:
 - Individual measurement evaluation (individual report) = BTpro_Report_Logo.jpg
 - Multiple measurement evaluation (multiple report) = BTpro_Job_Logo.jpg
 2. Start the Windows® Explorer®.
 3. Access the following path: **C:\ProgramData\Cellizer\CS-Manager\System**.
This is a program subfolder.

4. Copy your graphic into the folder.
The **Replace or Skip File** dialog appears.
5. Click the **Replace file in destination** button.
↳ Your graphic is saved and appears as a logo in the report.

Individual Report: Creating and Printing an Individual Measurement Evaluation

You can display a graphic evaluation of an individual measurement series ⇨ “Viewing Measurement Series” 25.

You can print most display types (with some exceptions, e.g. tabular views) as a report on paper or electronically as an Adobe® pdf file. If you can print the evaluation as a report, a printer icon appears at the top left above the graphic evaluation.

- ✓ Measurement data are available in BT PRO Manager ⇨ “Importing Measurement Data” 24.
1. Create a graphic evaluation, for example a bar chart or a history ⇨ “Viewing Measurement Series” 25.
 2. Click the  button.
The **Preview** dialog appears.
 3. Optional: Activate the **OK** or **NOK** checkbox for an assessment of the measurement results.
 4. Click the appropriate icon for the desired type of print-out:
 -  for the printer specified on your PC
 - Adobe® PDF Logo for a pdf file
 The respective print dialog opens.
 5. Follow the instructions displayed in the print dialog. If necessary, read any relevant product documentation.
- ↳ The report is printed.

Multiple Report: Creating and Printing a Multiple Measurement Evaluation

You can create and print multiple reports, i.e. evaluations of several measurement series.

A multiple report contains several measurement series, all of which originate from a single job. A job is a collection container for measurement series and is identified by an ID.

Jobs are created automatically for float (⇨ 33), discharge (⇨ 35) and charge (⇨ 37) measurements. In order to obtain a job ID, right click the measurement series in the **display selection** and select **Show Job ID**.

Job IDs are not assigned to individual measurements, which is indicated by the number “0”. They can be added to a job which belongs to the same battery. In this case they’re assigned the same job ID and appear in the multiple report. Conversely, the job ID can also be removed so that the measurement series no longer belongs to the job and doesn’t appear in the multiple report.

Measurement series without a job ID are identified by means of an empty square in the **display selection**, and the square is filled in for measurement series with a job ID.

In addition to combining measurement series, you can also customize the report, for example:

- Selection of elements to be printed
- Add evaluations: overall evaluation and element evaluations
Green = OK
Orange = warning
Red = NOK
- Add images (png, jpg, jpeg or bmp format)
- Add notes and comments: any desired text or text modules for frequently occurring elements

Optionally, the report can be printed on paper or electronically as an Adobe® pdf file.

- ✓ Measurement data are available in BT PRO Manager ⇨ “Importing Measurement Data” 24.
1. Start BT PRO Manager.
 2. Click the **Display Measurement Series** button.
The **Measurements** menu appears in the **display selection**.

3. Select the desired type of measurement from the list.
Depending on the selected list entry, the following appears in the **display selection**:
 - Folder view = locations and batteries
 - Most recent = all measurements in descending chronological order
 - Specific measuring function = all measurements of the selected type in descending chronological order
 The first measurement series is selected automatically.
The measured values are displayed in the **detail display area**.
 4. Select a measurement series with job ID (indicated by a filled in square) from the **Measurement Series Selection** list in the **display selection**.
The measured values of the selected measurement series are displayed in tabular form in the **detail display area**.
 5. Right click the measurement series.
The context menu appears.
 6. Click **Open Job**.
The job is displayed in the **detail display area**.
 7. Click the  button.
The job can be edited.
 8. Click another measurement series in the **display selection** which belongs to the same battery (which can be recognized by means of the ID) and hold the mouse button down. Drag the measurement series to the **Assigned** area.
The measurement series is added to the report.
 9. Repeat step 8 as required.
 10. Enter checkmarks in the **Print area** for the elements you want to include in the multiple report.
- Optional – add an evaluation:
11. Create an assessment in the **Evaluation, Battery-Specific** and **Block-Specific** areas. Activate the checkboxes to this end, or fill in the fields with limit values.

Optional – add images:

12. Click the Add Image button.
The **Open** dialog appears.
13. Select a graphic.
The graphic is added. A **PHOTO** element appears in the **Assigned** area. In order to edit (add a comment to) or remove the graphic, right-click it and select the corresponding context menu item.
14. Repeat steps 12 and 13 for additional images.

Optional – add remarks and comments:



Create a text block or select an existing one. Alternatively, or additionally, you can enter any desired text.

15. Click the + button in the **Insert Text Block** area.
16. Enter a name for the text block in the Selection field.
17. Enter any desired text to the text field.
18. Click the + button.
The text block is saved and selected.
19. If text blocks have already been created, choose a text block from the list in the **Insert Text Block** area.
The text block is selected and is displayed in the **Remarks** field.
20. Enter any desired text to the **Remarks** field.

Then save the multiple report settings.

21. Click the  button.
The settings for the multiple report are saved.

Optional – print the report:

22. Click the  button.
The **Preview** dialog appears.
23. Click the appropriate icon for the desired type of print-out:
 -  for the printer specified on your PC
 - Adobe® PDF Logo for a pdf file
 The respective print dialog opens.
24. Follow the instructions displayed in the print dialog. If necessary, read any relevant product documentation.
 - ↳ The report is printed.
 Close the job by clicking the **X** button in order to continue working with the program.

9 Preparing Measurements

9.1 General Information (procedure)

Certain preparations must be completed before performing measurements:

1. Install BT PRO Manager software ⇨ 18.
2. Create a battery database with BT PRO Manager ⇨ 18.
You can manage all of your devices under test (batteries) in the battery database, making it possible to select them during measurement. The limit values required for the measurement are defined in the database as well. If the specified limit values are exceeded during a measurement, a brief acoustic signal is generated and the measured value is displayed with a black background.

If you've already completed this step, double check and update your battery database.

Note

Devices under test can also be defined at the instrument. However, manually entered DUTs and their associated measurement data cannot be transferred to the battery database / BT PRO Manager. In order to transfer data, the DUT must first be entered (a second time) to the software. And thus devices under tests should only be entered manually in exceptional situations, for example if you encounter unforeseen changes on site.

3. Transfer the battery database to the battery tester ⇨ 23.
 4. Optional: If you're using an RFID system, assign the RFID tags to the DUTs (batteries) via the battery database ⇨ 24.
 5. Switch polarity on or off ⇨ 28.
If necessary, the polarity of the measured value doesn't have to be taken into account for the **FLOAT**, **DISCHARGE**, **CHARGE** and **CONNECTOR** measurements. All measured values are then positive (absolute values).
 6. Inform yourself concerning use of the accessories ⇨ 28.
The battery tester's accessories are used for some measurements. Before beginning a measurement, familiarize yourself with how to connect the accessories and use for intended purpose.
- ↳ The various measurements can now be performed ⇨ 30.

9.2 Switching Polarity On or Off

When this function is switched on, the polarity of the measured value is taken into account for the **float**, **discharge** and **charge** measurements.

If the function is switched off, the polarity of the measured value isn't taken into account for the **float**, **discharge** and **charge** measurements. In this case, all measured values are positive (absolute values).

1. Switch the battery tester on ⇨ 7.
2. Press the **OK** key.
The **main menu** appears.
3. Select → **SETTINGS** from the **main menu** using the ▼ ▲ keys.
The **SETTINGS** menu is displayed.
4. Press the **OK** key.
The **SETTINGS** menu is displayed.
5. Select → **MEASUREMENTS** using the ▼ ▲ keys.
6. Press the **OK** key.
The **MEASUREMENTS** appear.
7. Select → **POLARITY ON** or **POLARITY OFF** using the ▼ ▲ keys.
8. Press the **OK** key.
↳ The setting is accepted and identified by means of a preceding dot.

9.3 Connecting Measuring Accessories

Depending on the measurement, various measuring accessories are connected to the battery tester. Which accessories are used for which measurement is specified for each respective measurement ⇨ "BT PRO Manager" PC Software 18.

Before using an accessory, read the following information and the product documentation for the accessory.

Set of Multimeter Test Probes (KS29)

The included set of multimeter test probes consists of measurement cables with test probes. Each test probe is equipped with a safety cap.

Table 9: Set of Multimeter Test Probes

Measuring category	See labeling on device
Test probe diameter	4 mm
Plug	90° angled safety plug

Attention!

Only perform measurements with the measurement cables included in the test probe set with the safety caps attached. The safety caps may only be removed when using the alligator clips, after which they must be reattached ⇨ "Alligator Clips (KY95-3)" 28.

Attention!

Never touch the conductive ends of the test probes.

Connection and use of the multimeter test probes are described within the context of each respective measurement ⇨ 32 ff.

Alligator Clips (KY95-3)

Alligator clips provide a detachable clamp connection for measurements conducted over longer periods of time.

Table 10: Alligator Clips (KY95-3)

Measuring category	See labeling on device
--------------------	------------------------

Attention!

Never touch the conductive ends of the alligator clips.

The alligator clips are plugged onto the multimeter test probes:

- ✓ The multimeter test probe measurement cables are not connected to the battery tester.
 - ✓ The multimeter test probes are not making contact.
1. Remove the protective cap from the red multimeter test probe. Keep the protective cover in a safe place. You'll need it again later.
 2. Attach the red alligator clip to the red multimeter test probe.
 3. Repeat the previous steps with the black multimeter test probe and the black alligator clip.
- ↳ The alligator clips can be used for measurements ⇨ 18.
After measurement has been completed, remove the alligator clips and return the protective caps:
- ✓ The multimeter test probe measurement cables are not connected to the battery tester.
 - ✓ The alligator clips are not making contact.
1. Remove the alligator clip from the red multimeter test probe.
 2. Attach a protective cap to the red multimeter test probe.
 3. Repeat the previous steps with the black alligator clip and the black multimeter test probe.
- ↳ The multimeter test probes can be used for measurements ⇨ 18.

Kelvin Probes (Z227D) for 4-Wire Measurement

Electrical resistance is a dipole which can generally be measured using two poles. A measuring current of predetermined magnitude is directed through the device under test to this end and the resultant voltage drop is measured. The respective resistance value is derived from the quotient of these two values. The two points between which voltage is measured are decisive as regards the results of the measurement. All resistances between these two points (e.g. cable resistance) add to the measured resistance value.

The included Kelvin probe can be used for measurement in order to avoid this. In order to get the measuring device's voltage measurement potential points as close as possible to the device under test, the probe has separate connections for current supply and voltage measurement. This type of 4-pole connection is known as connection according to Kelvin.

Table 4: Kelvin Probes

Measuring category	See labeling on device
---------------------------	------------------------

Attention!

Never touch the conductive ends of the Kelvin probes.

Attention!

The Kelvin probes may only be used at the METRACELL BT PRO battery tester for the measurement of "resistance" (⇒  39).

Connection and use of the Kelvin test probes are described within the context of the "resistance" measurement ⇒  39.

Attention!

Only use the Kelvin probes accessory (Z227D) in CAT 0 measuring category environments.
The Kelvin probes (Z227D) may not be used in measuring categories CAT II, III or IV.

10 Performing Measurements

Various measurements can be performed with the battery tester:

Measurement	Description
MULTIMETER	DC and AC voltage measurements without storing measured values
FLOAT	Periodic measurement of block voltages. This measurement is used for quarterly recording of float voltage, for example in UPS systems.
DISCHARGE	Multiple measurement of block voltages at short intervals during discharging (capacity test)
CHARGE	Multiple measurement of block voltages at short intervals during charging (capacity test)
RESISTANCE	Periodic measurement of the internal resistance of the blocks
TEMPERATURE	Measurement of block temperature with an IR temperature sensor
CONNECTOR	Measurement of voltage drop to determine connector loss between blocks
INTERVAL U	Measurement of the voltage of a battery at any desired time intervals (voltage curve)
INTERVAL U + I	Measurement of the voltage and current of a battery at any desired time intervals (voltage and current curves) Example: Recording of discharge current during discharging.
DMA 35 (IrDA)	Measurement of acid density and electrolyte temperature within a block. Measurements are performed with the DMA 35 density meter from Anton Paar GmbH.
DMA 35 (BT)	Measurement of acid density and electrolyte temperature within a block. Measurements are performed with the DMA 35 density meter from Anton Paar GmbH.

The following subsections describe how measurements are performed. First read the general information which contains basic information for all measurements (starting measurements, repeating measurement etc.), and the information concerning on-site selection of DUTs.

10.1 General Information

Starting Measurements

The following sections describe how specific measurements are performed. Follow the specified steps and make sure that the measuring points are properly contacted.

We recommend that you always contact the battery poles at the same measuring points when performing repeat measurements so that you obtain reproducible results.

On-Site Selection of the DUT to be Measured

In order to assign the measured values to a device under test (battery), the DUT must be selected during measurement.

While preparing for measurement (⇒ 18), you created a battery database with all DUTs and transferred it to the battery tester.

You can select the DUT from the battery database on site:

1. Via RFID (by scanning the RFID tag)
2. Via manual selection (using the keys on the battery tester)

If you encounter an unforeseen change on site, for example a new battery about which you had not been informed, you can enter a DUT manually.



Note

Only create DUTs manually in exceptional cases. Manually entered DUTs and their associated measurement data cannot be transferred to the battery database / BT PRO Manager. In order to transfer the data, the DUT must first be entered (a second time) to the software ⇒ “BT PRO Manager” PC Software ⇒ 18.

All 3 options are described in the following sections as part of the measurement procedure.

Ending or Aborting Measurements

As a rule, measurements are performed over all specified blocks. As soon as all measured values have been acquired, measurement is ended automatically.

A measurement can also be aborted. There are 2 way to do this:

1. Abort and save:
Press the **OK** key and acknowledge the security prompt with **OK**.
The measurement is aborted and the measured values are saved.
2. Abort without saving:
Press the **FUNCTION** key and acknowledge the security prompt with **OK**.
The measured values are saved to the battery tester, but are not transferred subsequently during data transfer.

If you abort a measurement by mistake, respond to the security prompt pressing the **FUNCTION** key. The display is returned to the measurement view.

----- appears at the display in order to indicate an incomplete or faulty measurement. Furthermore, **XXXXX** appears in the measured value display under the measurement's designation instead of the number of measured blocks.

An aborted measurement can be reactivated in order to finish it up correctly (see following section).

Reactivating an Aborted Measurement

A measurement identified as aborted (see above section) can always be reactivated.

1. Switch the battery tester on ⇒ 7.
2. Press the **OK** key.
The **main menu** appears.
3. Select → **DATA MENU** from the **main menu** using the ▼ ▲ keys.
The **DATA MENU** menu is displayed.
4. Select → **SHOW DATA** using the ▼ ▲ keys.

5. Press the **OK** key.
The menu for viewing the measurements is displayed ⇨ "Measured Values" 15.
 6. Select the measurement you want to reactivate using the ▼ ▲ keys.
 7. Press and hold the **FUNCTION** key until you hear a brief acoustic signal.
"XXXXX" changes to the number of blocks actually measured.
- ↳ The measurement is reactivated and can be continued.

Repeating a Measurement

Stored measurements can be repeated. Erroneous measured values can be corrected or re-measured in this way.

1. Switch the battery tester on ⇨ 7.
 2. Press the **OK** key.
The **main menu** appears.
 3. Select → **DATA MENU** from the **main menu** using the ▼ ▲ keys.
The **DATA MENU** menu is displayed.
 4. Select → **SHOW DATA** using the ▼ ▲ keys.
 5. Press the **OK** key.
The menu for viewing the measurements is displayed ⇨ "Measured Values" 15.
 6. Use the ▼ ▲ key to select the measurement from which you want to measure a value again.
 7. Select the measured value you want to measure again using the ▼ ▲ keys.
(Some measurements have only one measured value. No selection is possible in this case.)
 8. Press the **OK** key.
The detail view is displayed.
 9. Press and hold the **OK** key (approx. 2 seconds) until you hear a brief acoustic signal.
 10. Measure the measured value again.
- ↳ The measured value is saved.

Editing or Viewing Measurements

You can view and edit all measurements stored in the battery tester directly at the instrument. This makes it possible to conduct initial checking of the measurement results on site.

Normally, the measured values are displayed in black. However, if a limit value is violated, the measured value is displayed with a light-colored font and a black background for emphasis.

For a better overview, and for evaluation of the measurement results, transfer the measurement data to BT PRO Manager software. Reports can also be generated with this program.

Complete information on working with measurement data can be found in section on "Viewing, Editing, Transferring and Evaluating Measured Values" ⇨ 50.

10.2 Multimeter Measurements

Simple DC and AC voltage measurements can be performed with the **MULTIMETER** measuring function.

Se-quence	Description of the Measurement	Display
1	Connect the multimeter test probe measurement cables to the connector sockets with the matching colors (⇒ "Measurement Inputs" 5) according to measuring range: $\pm 2.45 V_{DC}$: P-/COM and S- $\pm 24.5 V_{DC}$: P-/COM and S+ $\pm 600 V_{DC}$: P-/COM and S+ $300 V_{AC}$: P-/COM and S+	
2	Press and hold the FUNCTION key for about 2 seconds in order to switch the battery tester on.	BTpro <date> <version> <time>
3	Press any key to open the main menu . If you're already in another menu, press the FUNCTION key repeatedly until the main menu appears.	-> MEASUREMENT DATA
4	Press the OK key in order to open the MEASUREMENTS menu. The MULTIMETER measuring function is already selected.	-> MULTIMETER FLOAT
5	Press the OK key in order to open the menu for the measuring function.	-> 2.45 VDC (S-) 24.5 V DC (S+)
6	Select the measuring range using the ▼ ▲ keys.	-> 600 VDC (S+) 300 VAC (S+)
7	Start the measurement by pressing the OK key.	<date> <time>
9	Contact the battery poles: Using suitable pressure, press the multimeter test probes against the poles.	-----Hz X.XX V _{AC}
10	The measured value is displayed.	
11	Remove the multimeter test probes from the poles.	
12	End the measurement by pressing the OK key.	-> MULTIMETER FLOAT

10.3 Float Measurement

The **FLOAT MEASUREMENT** is a test procedure by means of which the voltage values of all batteries or blocks of a battery system are measured. The measurement is performed regularly at certain intervals, e.g. as a quarterly inspection of a UPS system.



Note

Polarity can be switched off ⇨ 28. If polarity is switched off, the absolute value of the measured value is recorded.



Note

Perform the **FLOAT** measurement before conducting temperature or acid density measurements.

Se- quence	Description of the Measurement	Display
1	Connect the multimeter test probe measurement cables to the P-/COM and S+ sockets with the matching colors (⇨ "Measurement Inputs" 5).	
2	Press and hold the FUNCTION key for about 2 seconds in order to switch the battery tester on.	BTpro <date> <version> <time>
3	Press any key to open the main menu . If you're already in another menu, press the FUNCTION key repeatedly until the main menu appears.	-> MEASUREMENT DATA
4	Press the OK key in order to open the MEASUREMENTS menu. The MEASUREMENTS menu is displayed.	-> MULTIMETER FLOAT
5	Select → FLOAT with the ▼ key.	-> MULTIMETER FLOAT
6	Press the OK key in order to open the menu for the measuring function.	-> START SELECT.BATT
7	Before starting the measurement, the location, battery and limit value parameters must be set. These can be: – Selected in the battery database via RFID ⇨ step 7a. – Selected manually in the battery database ⇨ step 7b. – Entered manually at the battery tester ⇨ step 7c.	START -> SELECT.BATT
7a	✓ A battery database has been created ⇨ 18. ✓ The battery database has been transferred to the battery tester ⇨ 18. ✓ You use RFID technology for your system. ✓ The DUTs in the battery database are linked to the corresponding RFID tags ⇨ 24. 1. Select → SELECT.BATT with the ▼ key. 2. Press the OK key The battery database is displayed. An acoustic signal indicates that the RFID reader is ready. 3. Read the RFID tag (⇨ 5). An acoustic signal confirms reading and the DUT is displayed. 4. Press the OK key. ↳ The battery is selected. The battery tester returns to the MEASUREMENTS menu.	START -> SELECT.BATT
7b	✓ A battery database has been created ⇨ 18. ✓ The battery database has been transferred to the battery tester ⇨ 18. 1. Select → SELECT.BATT with the ▼ key. 2. Press the OK key The battery database is displayed. An acoustic signal indicates that the RFID reader is ready. 3. Select a battery using the ▼ ▲ keys. 4. Press the OK key. ↳ The battery is selected and the battery tester returns to the MEASUREMENTS menu.	START -> SELECT.BATT
7c	1. Select the AREA:XXXX parameter with the ▼ key. 2. Press the OK key. The entry mode is active. 3. Enter the parameter's first digit ⇨ 5. 4. Acknowledge your entry with the OK key. 5. Repeat steps 1 through 4 for all other parameter digits for battery number, number of blocks and upper and lower voltage limit values.	-> SELECT.BATT AREA: 000
8	Return to START using the ▲ key.	-> START SELECT.BATT
9	Press the OK key in order to start the measurement.	BLOCK - - - - - XXXX/X ----- AN:XXXX BN:XXXX

10	Wait for the acoustic signal which is generated when no voltage is applied to the multimeter test probes.	Example:
11	Contact the battery poles: Using suitable pressure, press the multimeter test probes against the poles.	BLOCK 12.2500V 0004/4
12	Wait for the acoustic signal which indicates that the measured value is stable. The measurement is hereby confirmed.	AN:0001 BN:0010
13	Remove the multimeter probes after hearing the acoustic signal.	
14	Wait for the acoustic signal once again, which indicates that the multimeter test probes are again voltage-free.	
15	Repeat the previously described measuring procedure for further battery blocks. The measurement is ended automatically after all blocks have been completely measured. The measured values are saved. The measured value evaluation appears at the display → 16.	
16	Press the OK key repeatedly in order to view the evaluation (scroll), and to subsequently return the display to the FLOAT measurement .	SUM: [XXXX] XX.XXXXXV AVER.: +XX.XXXXXV

10.4 Discharge Measurement

With the help of the **DISCHARGE** measuring function, battery or block voltages can be measured several times at short intervals while discharging (capacity test).



Note

At least two test runs must be completed for the discharge measurement.



Note

Polarity can be switched off ⇨ 28. If polarity is switched off, the absolute value of the measured value is recorded.

Se- quence	Description of the Measurement	Display
1	Connect the multimeter test probe measurement cables to the P-/COM and S+ sockets with the matching colors (⇨ "Measurement Inputs" 5).	
2	Press and hold the FUNCTION key for about 2 seconds in order to switch the battery tester on.	BTpro <date> <version> <time>
3	Press any key to open the main menu . If you're already in another menu, press the FUNCTION key repeatedly until the main menu appears.	-> MEASUREMENT DATA
4	Press the OK key in order to open the MEASUREMENTS menu. The MEASUREMENTS menu is displayed.	-> MULTIMETER FLOAT
5	Select → DISCHARGE with the ▼ ▲ keys.	-> FLOAT DISCHARGE
6	Press the OK key in order to open the selected menu for the measuring function.	-> START SELECT.BATT
7	Before starting the measurement, the location, battery and limit value parameters must be set. These can be: – Selected in the battery database via RFID ⇨ step 7a. – Selected manually in the battery database ⇨ step 7b. – Entered manually at the battery tester ⇨ step 7c.	-> START SELECT.BATT
7a	✓ A battery database has been created ⇨ 18. ✓ The battery database has been transferred to the battery tester ⇨ 18. ✓ You use RFID technology for your system. ✓ The DUTs in the battery database are linked to the corresponding RFID tags ⇨ 24. 1. Select → SELECT.BATT with the ▼ key. 2. Press the OK key The battery database is displayed. An acoustic signal indicates that the RFID reader is ready. 3. Read the RFID tag (⇨ 5). An acoustic signal confirms reading and the DUT is displayed. 4. Press the OK key. ↳ The battery is selected. The battery tester returns to the MEASUREMENTS menu.	-> START SELECT.BATT
7b	✓ A battery database has been created ⇨ 18. ✓ The battery database has been transferred to the battery tester ⇨ 18. 1. Select → SELECT.BATT with the ▼ key. 2. Press the OK key The battery database is displayed. An acoustic signal indicates that the RFID reader is ready. 3. Select a battery using the ▼ ▲ keys. 4. Press the OK key. ↳ The battery is selected and the battery tester returns to the MEASUREMENTS menu.	-> START SELECT.BATT
7c	1. Select the AREA:XXXX parameter with the ▼ key. 2. Press the OK key. The entry mode is active. 3. Enter the parameter's first digit ⇨ 5. 4. Acknowledge your entry with the OK key. 5. Repeat steps 1 through 4 for all other parameter digits for battery number, number of blocks and upper and lower voltage limit values.	-> SELECT.BATT AREA: 000
8	Return to START using the ▲ key.	-> START SELECT.BATT
9	Press the OK key in order to start the measurement.	BLOCK - - - - - XXXX/X ----- AN:XXXX BN:XXXX

10	Wait for the acoustic signal which is generated when no voltage is applied to the multimeter test probes.	Example:
11	Contact the battery poles: Using suitable pressure, press the multimeter test probes against the poles.	BLOCK 12.2500V 0004/4
12	Wait for the acoustic signal which indicates that the measured value is stable. The measurement is hereby confirmed.	AN:0001 BN:0010
13	Remove the multimeter probes after hearing the acoustic signal.	
14	Wait for the acoustic signal once again, which indicates that the multimeter test probes are again voltage-free.	
15	Repeat the previously described measuring procedure for further battery blocks. The measurement is ended automatically after all blocks have been completely measured. The measured values are saved. The measured value evaluation appears at the display → 16.	
16	Press the OK key repeatedly in order to view the evaluation (scroll), and to subsequently return the display to the DISCHARGE measurement.	SUM: [XXXX] XX.XXXXXV AVER.: +XX.XXXXXV

10.5 Charge Measurement

With the help of the **CHARGE** measuring function, battery or block voltages can be measured several times at short intervals while charging (capacity test).



Note

At least two test runs must be completed for the **charge** measurement.



Note

Polarity can be switched off ⇨ 28. If polarity is switched off, the absolute value of the measured value is recorded.

Se- quence	Description of the Measurement	Display
1	Connect the multimeter test probe measurement cables to the P-/COM and S+ sockets with the matching colors (⇨ "Measurement Inputs" 5).	
2	Press and hold the FUNCTION key for about 2 seconds in order to switch the battery tester on.	BTpro <date> <version> <time>
3	Press any key to open the main menu . If you're already in another menu, press the FUNCTION key repeatedly until the main menu appears.	-> MEASUREMENT DATA
4	Press the OK key in order to open the MEASUREMENTS menu. The MEASUREMENTS menu is displayed.	-> MULTIMETER FLOAT
5	Select → CHARGE using the ▼ ▲ keys.	-> DISCHARGE CHARGE
6	Press the OK key in order to open the selected menu for the measuring function.	-> START SELECT.BATT
7	Before starting the measurement, the location, battery and limit value parameters must be set. These can be: – Selected in the battery database via RFID ⇨ step 7a. – Selected manually in the battery database ⇨ step 7b. – Entered manually at the battery tester ⇨ step 7c.	-> START SELECT.BATT
7a	<ul style="list-style-type: none"> ✓ A battery database has been created ⇨ 18. ✓ The battery database has been transferred to the battery tester ⇨ 18. ✓ You use RFID technology for your system. ✓ The DUTs in the battery database are linked to the corresponding RFID tags ⇨ 24. <ol style="list-style-type: none"> 1. Select →SELECT.BATT with the ▼ key. 2. Press the OK key The battery database is displayed. An acoustic signal indicates that the RFID reader is ready. 3. Read the RFID tag (⇨ 5). An acoustic signal confirms reading and the DUT is displayed. 4. Press the OK key. ↳ The battery is selected. The battery tester returns to the MEASUREMENTS menu. 	-> START SELECT.BATT
7b	<ul style="list-style-type: none"> ✓ A battery database has been created ⇨ 18. ✓ The battery database has been transferred to the battery tester ⇨ 18. <ol style="list-style-type: none"> 1. Select →SELECT.BATT with the ▼ key. 2. Press the OK key The battery database is displayed. An acoustic signal indicates that the RFID reader is ready. 3. Select a battery using the ▼ ▲ keys. 4. Press the OK key. ↳ The battery is selected and the battery tester returns to the MEASUREMENTS menu. 	-> START SELECT.BATT
7c	<ol style="list-style-type: none"> 1. Select the AREA:XXXX parameter with the ▼ key. 2. Press the OK key. The entry mode is active. 3. Enter the parameter's first digit ⇨ 5. 4. Acknowledge your entry with the OK key. 5. Repeat steps 1 through 4 for all other parameter digits for battery number, number of blocks and upper and lower voltage limit values. 	-> SELECT.BATT AREA: 000
8	Return to START using the ▲ key.	-> START SELECT.BATT
9	Press the OK key in order to start the measurement.	BLOCK - - - - - XXXX/X ----- AN:XXXX BN:XXXX

10	Wait for the acoustic signal which is generated when no voltage is applied to the multimeter test probes.	Example: BLOCK 12.2500V 0004/4 <hr/> AN:0001 BN:0010
11	Contact the battery poles: Using suitable pressure, press the multimeter test probes against the poles.	
12	Wait for the acoustic signal which indicates that the measured value is stable. The measurement is hereby confirmed.	
13	Remove the multimeter probes after hearing the acoustic signal.	
14	Wait for the acoustic signal once again, which indicates that the multimeter test probes are again voltage-free.	
15	Repeat the previously described measuring procedure for further battery blocks. The measurement is ended automatically after all blocks have been completely measured. The measured values are saved. The measured value evaluation appears at the display → 16.	
16	Press the OK key repeatedly in order to view the evaluation (scroll), and to subsequently return the display to the CHARGE measurement.	SUM: [XXXX] XX.XXXXXV AVER.: +XX.XXXXXV

10.6 Resistance Measurement

Voltages and internal resistances are measured across all blocks of a battery with the **RESISTANCE** measuring function.

As a special feature of the internal resistance measurement, “electrical resistance R_{el} ” and “charge transfer resistance R_{ct} ” are measured simultaneously. Total internal resistance is arrived at by combining these two resistance values:

- “Electrical resistance R_{el} ” represents strictly electrical losses. These losses occur at, for example, plate straps, plate grids and electrolytes. The battery delivers rapidly changing currents via this resistance, for example for switched-mode DC/DC converters.
- “Charge transfer resistance R_{ct} ” is used to characterize the ability of a block to accumulate and release a charge. This makes it possible to identify battery blocks which are operating at a loss with regard to float.

Measurement is performed as a 4-wire measurement and Kelvin probes (accessory Z227D) are used in order to compensate for cable resistance → 29.

Attention!

Caution: Sparking

During the resistance measurement, test current flows which may result in sparking.

Resistance measurement

- May only be performed where hydrogen concentrations in the air comply with DIN EN 50272-2
- Must not be performed immediately after the battery system has been charged – wait for at least 30 minutes
- May only be performed in well-ventilated battery rooms

- ✓ The Kelvin probes (Z227D, accessory) are available.
- ✓ Polarity is switched on.

Se-quence	Description of the Measurement	Display
1	Connect the Kelvin probes (Z227D → 28) to the sockets (→ “Measurement Inputs” 5) as follows: <ul style="list-style-type: none"> – Connect the black cable with the double plug such that the plug segment with the red ring is connected to S– and the purely black plug segment is connected to P–/COM. – Connect the red cable with the double plug such that the plug segment with the red ring is connected to S+ and the purely black plug segment is connected to P+. 	
2	Press and hold the FUNCTION key for about 2 seconds in order to switch the battery tester on.	BTpro <date> <version> <time>
3	Press any key to open the main menu . If you’re already in another menu, press the FUNCTION key repeatedly until the main menu appears.	-> MEASUREMENT DATA
4	Press the OK key in order to open the MEASUREMENTS menu. The MEASUREMENTS menu is displayed.	-> MULTIMETER FLOAT
5	Select → RESISTANCE using the ▼ ▲ keys.	-> CHARGE RESISTANCE
6	Press the OK key in order to open the selected menu for the measuring function.	-> START SELECT.BATT
7	Before starting the measurement, the location, battery and limit value parameters must be set. These can be: <ul style="list-style-type: none"> – Selected in the battery database via RFID → step 7a. – Selected manually in the battery database → step 7b. – Entered manually at the battery tester → step 7c. 	-> START SELECT.BATT
7a	<ul style="list-style-type: none"> ✓ A battery database has been created → 18. ✓ The battery database has been transferred to the battery tester → 18. ✓ You use RFID technology for your system. ✓ The DUTs in the battery database are linked to the corresponding RFID tags → 24. <ol style="list-style-type: none"> 1. Select → SELECT.BATT with the ▼ key. 2. Press the OK key The battery database is displayed. An acoustic signal indicates that the RFID reader is ready. 3. Read the RFID tag (→ 5). An acoustic signal confirms reading and the DUT is displayed. 4. Press the OK key. ↳ The battery is selected. The battery tester returns to the MEASUREMENTS menu. 	-> START SELECT.BATT

10.7 Temperature Measurement

The battery's individual block temperatures can be measured with the **TEMPERATURE** measuring function. The optionally available temperature sensor (METRATHERM IR BASE) is required for this measurement → 3.

Note

Read and adhere to the documentation included with the METRATHERM IR BASE temperature sensor.

- ✓ The METRATHERM IR BASE temperature sensor is available.

Se-quence	Description of the Measurement	Display
1	Connect the temperature sensor as follows (→ "Measurement Inputs" 5): – Red plug to S– – Black plug to P-/COM	
2	Press and hold the FUNCTION key for about 2 seconds in order to switch the battery tester on.	BTpro <date> <version> <time>
3	Press any key to open the main menu . If you're already in another menu, press the FUNCTION key repeatedly until the main menu appears.	-> MEASUREMENT DATA
4	Press the OK key in order to open the MEASUREMENTS menu. The MEASUREMENTS menu is displayed.	-> MULTIMETER FLOAT
5	Select → TEMPERATURE using the ▼ ▲ keys.	-> RESISTANCE TEMPERATURE
6	Press the OK key in order to open the selected menu for the measuring function.	-> START SELECT.BATT
7	Before starting the measurement, the location, battery and limit value parameters must be set. These can be: – Selected in the battery database via RFID → step 7a. – Selected manually in the battery database → step 7b. – Entered manually at the battery tester → step 7c.	-> START SELECT.BATT
7a	✓ A battery database has been created → 18. ✓ The battery database has been transferred to the battery tester → 18. ✓ You use RFID technology for your system. ✓ The DUTs in the battery database are linked to the corresponding RFID tags → 24. 1. Select → SELECT.BATT with the ▼ key. 2. Press the OK key The battery database is displayed. An acoustic signal indicates that the RFID reader is ready. 3. Read the RFID tag (→ 5). An acoustic signal confirms reading and the DUT is displayed. 4. Press the OK key. ↳ The battery is selected. The battery tester returns to the MEASUREMENTS menu.	-> START SELECT.BATT
7b	✓ A battery database has been created → 18. ✓ The battery database has been transferred to the battery tester → 18. 1. Select → SELECT.BATT with the ▼ key. 2. Press the OK key The battery database is displayed. An acoustic signal indicates that the RFID reader is ready. 3. Select a battery using the ▼ ▲ keys. 4. Press the OK key. ↳ The battery is selected and the battery tester returns to the MEASUREMENTS menu.	-> START SELECT.BATT
7c	1. Select the AREA:XXXX . parameter with the ▼ key. 2. Press the OK key. The entry mode is active. 3. Enter the parameter's first digit → 5. 4. Acknowledge your entry with the OK key. 5. Repeat steps 1 through 4 for all other parameter digits for battery number, number of blocks and upper and lower voltage limit values.	-> SELECT.BATT AREA: 000
8	Return to START using the ▲ key.	-> START SELECT.BATT

9	Press the OK key in order to start the measurement.	BLOCK XXXX/X	-----
10	Aim the IR temperature sensor at a suitable measuring point (e.g. minus pole) on the block.	AN:XXXX	BN:XXXX
11	Press and hold the measurement activation key on the sensor.		
12	Wait until a stable measured value is displayed.		
13	Acknowledge the measured value at the battery tester by pressing the OK key.		
14	Repeat the previously described measuring procedure for further battery blocks. The measurement is ended automatically after all blocks have been completely measured. The measured values are saved. The measured value evaluation appears at the display → 16.	Example: BLOCK 0004/2	21.8 C
		AN:0001	BN:0010
15	Press the OK key repeatedly in order to view the evaluation (scroll), and to subsequently return the display to the TEMPERATURE measurement.	NUMBER: [XXXX]	
		AVER.:	XX.XXXX C

10.8 Connector Measurement

The **CONNECTOR** measurement function is used to ascertain losses which occur at the connectors with which the batteries are connected. Voltage drop between the connected poles is measured.



Note

Measure all connectors during a capacity test with constant current.



Note

Polarity can be switched off ⇨ 28. If polarity is switched off, the absolute value of the measured value is recorded.

Se-quence	Description of the Measurement	Display
1	Connect the multimeter test probe measurement cables to the P-/COM and S- sockets with the matching colors (⇨ "Measurement Inputs" 5).	
2	Press and hold the FUNCTION key for about 2 seconds in order to switch the battery tester on.	BTpro <date> <version> <time>
3	Press any key to open the main menu . If you're already in another menu, press the FUNCTION key repeatedly until the main menu appears.	-> MEASUREMENT DATA
4	Press the OK key in order to open the MEASUREMENTS menu. The MEASUREMENTS menu is displayed.	-> MULTIMETER FLOAT
5	Select → CONNECTOR using the ▼ ▲ keys.	-> TEMPERATURE CONNECTOR
6	Press the OK key in order to open the selected menu for the measuring function.	-> START SELECT.BATT
7	Before starting the measurement, the location, battery and limit value parameters must be set. These can be: <ul style="list-style-type: none"> – Selected in the battery database via RFID ⇨ step 7a. – Selected manually in the battery database ⇨ step 7b. – Entered manually at the battery tester ⇨ step 7c. 	-> START SELECT.BATT
7a	<ul style="list-style-type: none"> ✓ A battery database has been created ⇨ 18. ✓ The battery database has been transferred to the battery tester ⇨ 18. ✓ You use RFID technology for your system. ✓ The DUTs in the battery database are linked to the corresponding RFID tags ⇨ 24. <ol style="list-style-type: none"> 1. Select → SELECT.BATT with the ▼ key. 2. Press the OK key The battery database is displayed. An acoustic signal indicates that the RFID reader is ready. 3. Read the RFID tag (⇨ 5). An acoustic signal confirms reading and the DUT is displayed. 4. Press the OK key. ↳ The battery is selected. The battery tester returns to the MEASUREMENTS menu. 	-> START SELECT.BATT
7b	<ul style="list-style-type: none"> ✓ A battery database has been created ⇨ 18. ✓ The battery database has been transferred to the battery tester ⇨ 18. <ol style="list-style-type: none"> 1. Select → SELECT.BATT with the ▼ key. 2. Press the OK key The battery database is displayed. An acoustic signal indicates that the RFID reader is ready. 3. Select a battery using the ▼ ▲ keys. 4. Press the OK key. ↳ The battery is selected and the battery tester returns to the MEASUREMENTS menu. 	-> START SELECT.BATT
7c	<ol style="list-style-type: none"> 1. Select the AREA:XXXX. parameter with the ▼ key. 2. Press the OK key. The entry mode is active. 3. Enter the parameter's first digit ⇨ 5. 4. Acknowledge your entry with the OK key. 5. Repeat steps 1 through 4 for all other parameter digits for battery number, number of blocks and upper and lower voltage limit values. 	-> SELECT.BATT AREA: 000
8	Return to START using the ▲ key.	-> START SELECT.BATT

9	Press the OK key in order to start the measurement.	BLOCK XXXX/X ----- AN:XXXX BN:XXXX
10	Contact the connector: using suitable pressure, press the multimeter test probes against the connection points.	Example:
11	Wait until the measured value settles in.	BLOCK 2513.15mV 0004/2
12	Press the OK key in order to acknowledge the measured value. The measured value is saved.	AN:0001 BN:0010
13	Remove the multimeter probes after hearing the acoustic signal.	
14	Repeat the previously described measuring procedure for further connection points. The measurement is ended automatically after all connection points have been completely measured. The measured values are saved. The measured value evaluation appears at the display ⇨ 16.	BLOCK ----- XXXX/X AN:XXXX BN:XXXX
15	Press the OK key repeatedly in order to view the evaluation (scroll), and to subsequently return the display to the CONNECTOR measurement.	NUMBER [XXXX] AVER.: XXXX.XXmV

10.9 Interval U Measurement

The **INTERVAL U** measuring function is used to measure voltage at any desired time intervals (voltage curve). The shortest selectable time interval is 1 second. Measurement is continued at the specified time interval until ended by the user.

Se- quence	Description of the Measurement	Display
1	Plug the alligator clips (⇒ 28) onto the multimeter test probe measurement cables and connect them to the P-/COM and S+ sockets with the matching colors (⇒ "Measurement Inputs" 5).	
2	Connect the alligator clips to the battery's power output: red to plus, black to minus.	
3	Press and hold the FUNCTION key for about 2 seconds in order to switch the battery tester on.	BTpro <date> <version> <time>
4	Press any key to open the main menu . If you're already in another menu, press the FUNCTION key repeatedly until the main menu appears.	-> MEASUREMENT DATA
5	Press the OK key in order to open the MEASUREMENTS menu. The MEASUREMENTS menu is displayed.	-> MULTIMETER FLOAT
6	Select → INTERVALL U using the ▼ ▲ keys.	-> CONNECTOR INTERVAL U
7	Press the OK key in order to open the selected menu for the measuring function.	-> START SELECT.BATT
8	Before starting the measurement, the location, battery and limit value parameters must be set. These can be: – Selected in the battery database via RFID ⇒ step 9a – Selected manually in the battery database ⇒ step 9b – Entered manually at the battery tester ⇒ step 9c	-> START SELECT.BATT
8a	✓ A battery database has been created ⇒ 18. ✓ The battery database has been transferred to the battery tester ⇒ 18. ✓ You use RFID technology for your system. ✓ The DUTs in the battery database are linked to the corresponding RFID tags ⇒ 24. 1. Select → SELECT.BATT with the ▼ key. 2. Press the OK key The battery database is displayed. An acoustic signal indicates that the RFID reader is ready. 3. Read the RFID tag (⇒ 5). An acoustic signal confirms reading and the DUT is displayed. 4. Press the OK key. ↳ The battery is selected. The battery tester returns to the MEASUREMENTS menu.	-> START SELECT.BATT
8b	✓ A battery database has been created ⇒ 18. ✓ The battery database has been transferred to the battery tester ⇒ 18. 1. Select → SELECT.BATT with the ▼ key. 2. Press the OK key The battery database is displayed. An acoustic signal indicates that the RFID reader is ready. 3. Select a battery using the ▼ ▲ keys. 4. Press the OK key. ↳ The battery is selected and the battery tester returns to the MEASUREMENTS menu.	-> START SELECT.BATT
8c	1. Select the AREA:XXXX. parameter with the ▼ key. 2. Press the OK key. The entry mode is active. 3. Enter the parameter's first digit ⇒ 5. 4. Acknowledge your entry with the OK key. 5. Repeat steps 1 through 4 for all other parameter digits for battery number and upper and lower voltage limit values.	-> SELECT.BATT AREA: 000
10	Return to START using the ▲ key.	-> START SELECT.BATT
11	Press the OK key in order to start the measurement.	COUNT: - - - - - XXXXXX ----- TIME: XX:XX:XX

12	Measurement is performed continuously until you either acknowledge or terminate it. The measured value is ascertained once per time interval and stored under the consecutive M-No. If the specified limit values are exceeded or fallen short of, a repetitive signal tone is generated.	Example: COUNT: 000002 12.200 V ----- TIME: 00:00:20
13	Press the OK key in order to end the measurement.	WANT TO QUIT WITH SAVING?
14	Disconnect the alligator clips from the battery poles.	
15	Confirm the prompt for saving the measured value by pressing the OK button . The measured value evaluation appears at the display ⇨ 16.	
16	Press the OK key repeatedly in order to view the evaluation (scroll), and to subsequently return the display to the INTERVAL U measurement.	COUNT: 000002 12.200 V ----- TIME: 00:00:40

10.10 Interval U+I Measurement

The **INTERVAL U+I** measuring function is used to measure voltage and current at any desired time intervals (voltage and current curve). The shortest selectable time interval is 1 second. Measurement is continued at the specified time interval until ended by the user. An optional AC/DC current clamp sensor (CP1800 or CP330) is required for the measurement → 3.



Note

Read and adhere to the documentation included with the AC/DC current clamp sensor (CP1800 or CP330)



Attention!

Danger of short-circuit if a shunt is measured incorrectly.

The measuring connections are not electrically isolated from each other. Only use the CP1800 or CP330 AC/DC current clamp sensor for current measurement (→ "Optional Accessories" 3).

✓ An AC/DC current clamp sensor is available: CP1800 for measurements up to 1250 A_{DC} or CP330 for measurements up to 300 A_{DC}.

Se-quence	Description of the Measurement	Display
1	Plug the alligator clips (→ 28) onto the multimeter test probe measurement cables and connect them to the P-/COM and S+ sockets with the matching colors (→ "Measurement Inputs" 5).	
2	Connect the alligator clips to the battery's power output: red to plus, black to minus.	
3	Connect the current clamp sensor: red measurement cable to socket S- and black measurement cable to the multimeter test probe connection at socket P-/COM (→ "Measurement Inputs" 5).	
4	Press and hold the FUNCTION key for about 2 seconds in order to switch the battery tester on.	BTpro <date> <version> <time>
5	Press any key to open the main menu . If you're already in another menu, press the FUNCTION key repeatedly until the main menu appears.	-> MEASUREMENT DATA
6	Press the OK key in order to open the MEASUREMENTS menu. The MEASUREMENTS menu is displayed.	-> MULTIMETER FLOAT
7	Select → INTERVALL U+I using the ▼ ▲ keys.	-> INTERVAL U INTERVAL U+I
8	Press the OK key in order to open the selected menu for the measuring function.	-> START SELECT.BATT
9	Before starting the measurement, the location, battery, limit value and current sensor parameters must be set. These can be: <ul style="list-style-type: none"> – Selected in the battery database via RFID → step 8a. – Selected manually in the battery database → step 8b – Entered manually at the battery tester → step 8c 	-> START SELECT.BATT
9a	<ul style="list-style-type: none"> ✓ A battery database has been created → 18. ✓ The battery database has been transferred to the battery tester → 18. ✓ You use RFID technology for your system. ✓ The DUTs in the battery database are linked to the corresponding RFID tags → 24. <ol style="list-style-type: none"> 1. Select → SELECT.BATT with the ▼ key. 2. Press the OK key The battery database is displayed. An acoustic signal indicates that the RFID reader is ready. 3. Read the RFID tag (→ 5). An acoustic signal confirms reading and the DUT is displayed. 4. Press the OK key. ↳ The battery is selected. The battery tester returns to the MEASUREMENTS menu. 	-> START SELECT.BATT
9b	<ul style="list-style-type: none"> ✓ A battery database has been created → 18. ✓ The battery database has been transferred to the battery tester → 18. <ol style="list-style-type: none"> 1. Select → SELECT.BATT with the ▼ key. 2. Press the OK key The battery database is displayed. An acoustic signal indicates that the RFID reader is ready. 3. Select a battery using the ▼ ▲ keys. 4. Press the OK key. ↳ The battery is selected and the battery tester returns to the MEASUREMENTS menu. 	-> START SELECT.BATT

9c	<ol style="list-style-type: none"> 1. Select the AREA:XXXX. parameter with the ▼ key. 2. Press the OK key. The entry mode is active. 3. Enter the parameter's first digit ⇨ 5. 4. Acknowledge your entry with the OK key. 5. Repeat steps 1 through 4 for all other parameter digits for battery number and upper and lower voltage limit values. 6. Use the ▼ ▲ keys to access the CLAMP A and CLAMP mV parameters. 7. Define the values for amperage and voltage for CLAMP A and CLAMP mV according to the ampere-volt ratio set at the current clamp. Example: Current clamp ratio = 1 A / 1 m means CLAMP A m = 0001 and CLAMP mV = 0010. 	<p>-> SELECT.BATT AREA: 000</p> <p>-> CLAMP A: 0001 LAMP V: 0010</p> <p>-> CLAMP A: 0001 LAMP V: 0010</p>
10	Return to START using the ▲ key.	-> START SELECT.BATT
11	Switch the current clamp sensor on.	
12	Press the zero balancing button for offset adjustment.	
13	Open the jaws of the current clamp sensor by opening the release.	
14	Enclose the positive line to the consumer with the open clamp jaws:	
15	Close the clamp jaws. Make sure that they're completely closed.	
16	Press the OK key in order to start the measurement.	<p>COUNT: ----- XXXXXX</p> <hr/> <p>TIME: XX:XX:XX</p>
17	<p>Measurement is performed continuously until you either acknowledge or terminate it. The measured value is ascertained once per time interval and stored under the consecutive M-No. If the specified limit values are exceeded or fallen short of, a repetitive signal tone is generated.</p>	<p>Example:</p> <p>COUNT: 000002 12.200 V</p> <hr/> <p>TIME: 00:00:20</p>
18	Press the OK key in order to end the measurement.	<p>WANT TO QUIT WITH SAVING?</p>
19	Switch the current clamp sensor off.	
20	Remove the current clamp sensor.	
21	Disconnect the alligator clips from the battery poles.	
22	Confirm the prompt for saving the measured value by pressing the OK button. The measured value evaluation appears at the display ⇨ 16.	<p>COUNT: 000002 12.200 V</p> <hr/> <p>TIME: 00:00:40</p>
23	Press the OK key repeatedly in order to view the evaluation (scroll), and to subsequently return the display to the INTERVAL U+I measurement.	

10.11 DMA35 Measurement (IrDA)

No measurements can be performed with the battery tester itself by means of this measuring function.

Instead, measured density and temperature values acquired by and stored in the portable DMA 35 density meter (version 3) from Anton Paar are transferred to the battery tester.



Note

Read the documentation included with the DMA 35 density meter from Anton Paar GmbH.

Data are transferred via infrared (IrDA).

- ✓ A CSV file is transferred from the DMA 35.
- ✓ The CSV file uses different characters as field separators and decimal characters.
(Use the default values as settings for the DMA 35.)

1. Select → **MEASUREMENT** from the **main menu** using the ▼ ▲ keys.
2. Press the **OK** key.
The **MEASUREMENT** menu is displayed.
3. Select → **DMA35 (IrDA)** using the ▼ ▲ keys.
4. Press the **OK** key.
The **DMA35 (IrDA)** menu is displayed.
5. Select → **START** using the ▼ ▲ keys.
6. Press the **OK** key.
WAITING FOR DMA 35 is displayed. The battery tester is waiting for data from the infrared interface.
7. Switch the **DMA 35** on.
8. Select the **Menu → Measurement Data → Export → Export All** function sequence at the **DMA 35**.
Calculate appears at the display.
9. Position the top of the **DMA 35** at a distance of about 10 cm from the infrared symbol on the battery tester.



Note

Ensure an undisturbed, uninterrupted infrared connection:

- The device's infrared transmitter and receiver must be directly opposite each other.
- Distance may not exceed 10 cm.

10. Connection is established.
WAITING FOR DMA 35 (RECEIVING DATA) appears at the battery tester. **Connection to PC** appears at the DMA 35.
11. The data are transmitted.
Transmission progress is displayed at the DMA 35: **<Export XXX%>**.
- ↳ Data are transferred from the DMA 35 to the battery tester. The battery tester displays the evaluation of the transmitted measured values.

10.12 DMA35 Measurement (BT)

No measurements can be performed with the battery tester itself by means of this measuring function.

Instead, measured density and temperature values acquired by and stored in the portable DMA 35 density meter (version 4) from Anton Paar are transferred to the battery tester.



Note

Read the documentation included with the DMA 35 density meter from Anton Paar GmbH.

Data are transferred via Bluetooth®.

- ✓ A CSV file is transferred from the DMA 35.
- ✓ The CSV file uses different characters as field separators and decimal characters.
(Use the default values as settings for the DMA 35.)

1. Select → **SETTINGS** from the **main menu** using the ▼ ▲ keys.
2. Press the **OK** key.
The **SETTINGS** menu is displayed.
3. Select → **BT SETTINGS** using the ▼ ▲ keys.
4. Press the **OK** key.
The **BT SETTINGS** menu is displayed.
5. Select → **LINK DMA35 V4** using the ▼ ▲ keys.
6. Press the **OK** key.
FIND BT PRO NOW WITH DMA is displayed. The battery tester can now be detected by the density meter.
7. Select the following function sequence at the density meter:
Menu → Settings → Data Transmission → Export Destination → OK → Start.
A search for the export destination is started.
8. Specify **BTPRO** as a device.
Connection is established.
9. Save your selection with **OK**.
10. Switch back to the main menu.
11. Go to the main menu at the battery tester.
12. Select → **MEASUREMENT** from the **main menu** at the battery tester using the ▼ ▲ keys.
13. Press the **OK** key.
The **MEASUREMENT** menu is displayed.
14. Select → **DMA35 (BT)** using the ▼ ▲ keys.
15. Press the **OK** key.
The **DMA35 (BT)** menu is displayed.
16. Select → **START** using the ▼ ▲ keys.
17. Press the **OK** key.
WAITING FOR DMA 35 is displayed. The battery tester is waiting for data.
18. Select the following function sequence at the **DMA 35**: **Menu → Data Memory → Export Measurement Data → OK**.
A security prompt appears.
19. Acknowledge the security prompt by clicking **Yes**.
The data are transmitted. **Exporting Data** appears at the **DMA 35**.
WAITING FOR DMA 35 (receiving data) appears at the battery tester.
- ↳ Data are transferred from the DMA 35 to the battery tester. The battery tester displays the evaluation of the transmitted measured values.

11 Viewing, Editing, Transferring and Evaluating Measured Values

Up to 300,000 data records can be stored to the instrument.

Measured values and measurement series stored to internal memory at the battery tester can be viewed and edited directly at the instrument. Brief measured value evaluations can also be viewed at the instrument. We recommend this method for a quick, initial visual assessment on site.

Transfer the measurement data to BT PRO Manager PC software for storage and further evaluation.

You can also save a backup copy of the data on a PC.

This section describes how to view and edit measured values at the instrument, and how to make data backups. Measurement data evaluation is described in section on “BT PRO Manager” PC Software” ⇨ 18.

11.1 Viewing Measured Values / Measured Value Details at the Instrument

Stored measured values, including measured value details, can be viewed directly at the instrument.

1. Switch the battery tester on ⇨ 7.
2. Press the **OK** key.
The **main menu** appears.
3. Select → **DATA MENU** from the **main menu** using the ▼ ▲ keys.
4. Press the **OK** key.
The **DATA MENU** menu is displayed.
5. Select → **SHOW DATA** using the ▼ ▲ keys.
6. Press the **OK** key.
The measurements are displayed.
 - The most recently stored measurement is displayed.
 - The measurements are listed chronologically.
7. Select the measurement you want to view using the ▼ ▲ keys.
 - Use the ▼ key to scroll forward in time.
 - Use the ▲ key to scroll back in time.
8. Press the **OK** key.
↳ The detail view is displayed. The display differs depending on the selected measurement ⇨ “Data Menu” 15. If there are several measurements per measurement function (e.g. in the case of a measurement series), you can scroll amongst the measured values in the detail view using the ▼ ▲ keys.

Note

Normally, the measured values are displayed in black. However, if a limit value is violated, the measured value is displayed with a light-colored font and a black background for emphasis.

11.2 Viewing Measured Value Evaluations at the Instrument

The battery tester automatically determines the sum, the mean value and the smallest and largest measured values for all stored measured values of a measurement series. You can view this brief evaluation at the instrument.

1. Switch the battery tester on ⇨ 7.
2. Press the **OK** key.
The **main menu** appears.
3. Select → **DATA MENU** from the **main menu** using the ▼ ▲ keys.
4. Press the **OK** key.
The **DATA MENU** menu is displayed.
5. Select → **SHOW DATA** using the ▼ ▲ keys.
6. Press the **OK** key.
The measurements are displayed.
7. Select the measurement you want to view using the ▼ ▲ keys.
8. Press the **OK** key repeatedly until the display appears with the calculated values associated with the respective measurement.
- ↳ The measured value evaluation is displayed ⇨ “Data Menu” 15. If several measured values were ascertained during a single measurement, you can scroll amongst the values displayed

in the evaluation using the ▼ ▲ keys.

After running through a full display cycle with the ▼ ▲ keys, the display is automatically switched back to the higher-level **SHOW DATA** menu.

11.3 Excluding a Measurement from Transmission (deactivate measurement)

If you've performed and saved a measurement that you don't want to take into account, you can subsequently deactivate it.

Deactivated measurements remain in memory at the battery tester, but aren't transferred during data transmission and are thus excluded from evaluation.

1. Switch the battery tester on ⇨ 7.
2. Press the **OK** key.
The **main menu** appears.
3. Select → **DATA MENU** from the **main menu** using the ▼ ▲ keys.
The **DATA MENU** menu is displayed.
4. Select → **SHOW DATA** using the ▼ ▲ keys.
 - Press the **OK** key.
The menu for viewing the measurements is displayed ⇨ “Measured Values” 15.
5. Select the measurement you want to deactivate using the ▼ ▲ keys.
6. Press and hold the **FUNCTION** key until you hear a brief acoustic signal.
The number of blocks changes to “XXXXX”.
- ↳ The measurement is deactivated.

11.4 Deleting Measured Values

Measurement data stored at the battery tester must be transferred to an external PC for data evaluation and storage.

After successful transmission, the measurement data in the battery tester can be deleted so that sufficient memory space is once again available for future measurements.

Note

All measurement data are deleted. Individual measurements cannot be deleted separately.

1. Switch the battery tester on ⇨ 7.
2. Press the **OK** key.
The **main menu** appears.
3. Select → **DATA MENU** from the **main menu** using the ▼ ▲ keys.
4. Press the **OK** key.
The **DATA MENU** menu is displayed.
5. Select → **CLEAR DATA** using the ▼ ▲ keys.
6. Press the **OK** key.
The **DO YOU REALLY WANT TO DELETE?** prompt appears.
7. Press the **OK** key.

Note

Press the **FUNCTION** key in order to abort deletion.

- ↳ All measured values stored at the battery tester are irretrievably deleted.

11.5 Saving Measured Values to a PC (data backup)

We recommend backing up measurement data to a PC or other external storage medium at regular intervals. Any possible loss of data can be prevented in this way.

When measurement data is transferred to BT PRO Manager software, an additional CSV file which contains the measurement data is automatically saved to the PC ⇨ “Importing Measurement Data” 24.

If you're not using BT PRO Manager, you can transfer the measurement data as a CSV file from the battery tester to a PC for backup via a Bluetooth® connection.

In either case, the file is saved to the PC and can be transferred to another medium or edited with a text editor.

Attention!

- The file may be damaged during editing.
- Before editing, save an additional backup copy.
 - Edit the CSV file with a text editor only. Microsoft® Excel® and other programs may destroy the file.

The filename for the CSV file must be specified before transferring the data. The battery tester and the PC must also be connected via Bluetooth®. Follow the instructions in the following sections, in the order specified, in order to transfer the measurement data.

Specifying Filename Nomenclature

You can choose between a uniform (always identical) or changing filename (with date and timestamp).

1. Switch the battery tester on  7.
2. Press the **OK** key.
The **main menu** appears. Select **→ SETTINGS** in the **main menu** using the **▼ ▲** keys.
3. Press the **OK** key.
The **SETTINGS** menu is displayed.
4. Select **→ CSV EXPORT** using the **▼ ▲** keys.
5. Press the **OK** key.
The **CSV EXPORT** menu is displayed
6. Select the desired nomenclature using the **▼ ▲** keys:
 - **FIXED FILENA.:** always the same filename
During transfer, the CSV file is named “BTPRO_Export.csv”.
 - **AUTO FILENA:** changing filenames
The file is named “BTPRO_Export_<System-ID>_<Date>_<Time>.csv”.
7. Press the **OK** key.
↳ The setting is saved.

Establishing a Bluetooth® Connection with a PC

The following instructions are provided as an example for a PC running Microsoft® Windows® 10. The procedure is similar for all other Microsoft® Windows® operating systems.

- ✓ A COM port (outgoing direction) on the PC is used for connection under Windows®. Read the documentation included with your operating system for detailed information.
1. Open the Windows® start menu.
 2. Click “Settings”.
The **Windows Settings** dialog opens.
 3. Click the **Devices** button.
The **Devices** dialog appears with the **Bluetooth & other devices** window.
 4. Switch the battery tester on  7.
 5. Press the **OK** key.
The **main menu** appears.
 6. Select **→ SETTINGS** from the **main menu** at the battery tester using the **▼ ▲** keys.
 7. Press the **OK** key.
The **SETTINGS** menu is displayed.
 8. Select **→ BT-SETTINGS** using the **▼ ▲** keys.
 9. Press the **OK** key.
The **BT SETTINGS** menu is displayed.
 10. Select **→LINK COMPUTER** using the **▼ ▲** keys.
 11. Press the **OK** key.
BT PAIRING: WAITING FOR PC is displayed.
 12. In Windows®, click the **Add Bluetooth or other device** button in the **Add Bluetooth & other devices** dialog.
The **Add a device** dialog appears.
 13. Click the **Bluetooth** button.
The system searches for Bluetooth® devices. After some time, the battery tester appears.

14. Click the battery tester.
Connection is established. The **CODE CORRECT?** message and a six-digit number appear at the battery tester. Information concerning the connection and a six-digit number are displayed at the PC.
15. Compare the six-digit numbers.
16. If the six-digit numbers are identical, press the **OK button** on the battery tester.
17. Click the **Connect button** in the **Add a device** dialog in Windows®.
Connection is established. The following message appears at the battery tester: **COMPUTER PAIRED? CONTINUE WITH KEY!**. The connection process is displayed at the PC, and finally a message indicating successful connection appears.
18. Click **Done** in the **Add a device** dialog in Windows®.
↳ The devices are connected.



Note

The Bluetooth® connection between the battery tester and the PC is automatically re-established after switching the devices off and back on again.
Manual disconnection is required in order to terminate the connection permanently  9.

Transferring a CSV File to the PC

1. Switch the battery tester on  7.
2. Press the **OK** key.
The **main menu** appears.
3. Select **→ SETTINGS** from the **main menu** using the **▼ ▲** keys.
4. Press the **OK** key.
The **SETTINGS** menu is displayed.
5. Select **→ CSV EXPORT** using the **▼ ▲** keys.
6. Press the **OK** key.
The **CSV EXPORT** menu is displayed
7. Select **→ EXPORT TARGET** using the **▼ ▲** keys.
8. Press the **OK** key.
SCANNING FOR BT DEVICES appears at the display.
9. After some time, your PC's name is displayed.
10. Open the Windows start window on the PC.
The Windows Start menu appears.
11. Click **Settings**.
The **Windows Setting** dialog appears.
12. Click **Devices**.
The **Bluetooth & other devices** dialog appears.
13. Click **More Bluetooth options** in the list on the right.
The **Bluetooth Settings** dialog is displayed.
14. Activate the **Allow Bluetooth devices to find this PC** checkbox in the **Options** tab.
The PC can be found by other devices.
15. Activate the other checkboxes as well.
16. Click the **OK** button.
The settings are saved. The **Bluetooth Settings** dialog is closed.
17. Click **Send or receive files via Bluetooth** in the list on the right-hand side of the **Bluetooth & other devices** dialog.
The **Bluetooth File Transfer** dialog is displayed.
18. Click **Receive files**.
19. Select the **→ DATA MENU → EXPORT (CSV)** function sequence in the **main menu** at the battery tester.

20. Press the **OK** key.

CONNECT BT CSV EXPORT appears briefly. The dialog box for entering the directory path then opens at the PC.

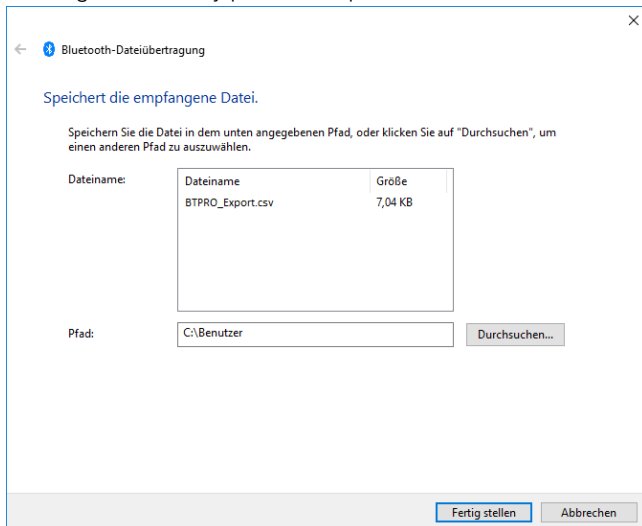

21. Specify a location for the file in the **Bluetooth File Transfer** dialog.

22. Click the **Finish** button.

↳ The data are transmitted. Information concerning transmission status is displayed at the battery tester, e.g. **CONNECTING, CALCULATING DATA, TRANSMITTING DATA**. When **EXPORT (CSV)** appears at the display again, data transfer has been completed.

12 Maintenance

12.1 Firmware Update

The battery tester's firmware is updated to the latest version by means of a firmware update, so that it always functions reliably and safely. The battery tester can also be expanded to include additional functions with the help of new firmware.

1. Switch the battery tester on ⇨ 7.
2. Press the **OK** key.
The **main menu** appears.
3. Select → **INFO** from the **main menu** using the ▼ ▲ keys.
4. Press the **OK** key.
The instrument's current firmware version is displayed.
5. Open the myGMC service portal in a browser:
<http://www.gmc-instruments.de/services/mygmc/>
6. Log in using the account you created when you installed BT PRO Manager software ⇨ 18.
7. Select your METRACELL BT PRO from the registered products by clicking **Details**.
The **Additional Information** page appears.
8. Compare the version of the currently available firmware with that of your instrument.
 - If these are identical, no action is required.
 - If a newer firmware version is available, follow the steps listed below.
9. Read and observe the **Description of Changes and Additional Functions**.
10. Download the new firmware to your PC.
11. Establish a Bluetooth® connection between your PC and the battery tester ⇨ "Establishing a Bluetooth® Connection with a PC" 51.
12. Switch the battery tester off.
13. Press and hold the **OK** key. Additionally press the **Function** key until **BOOTLOADER START SYSTEM** appears at the display.
After a short time, **WAITING FOR COM** is displayed.
14. Run the exe file on your computer.
15. Follow the instructions displayed by the installation wizard.
16. The battery tester's firmware is updated.
Various messages appear during the update. **FLASHING COMPLETED** appears at the display as soon as updating has been completed.
17. Press the **OK** key.
The instrument is switched to its initial display.
18. Press any key.
↳ The **main menu** appears at the display. The instrument can now be used.

12.2 Housing and Display

No special maintenance is required for the housing. Keep outside surfaces clean. Use a cloth for cleaning, which has been slightly dampened with water.



Attention!

Avoid the use of cleansers, abrasives or solvents!

12.3 Measurement Cables

Inspect the measurement cables, i.e. all cables, for damage at regular intervals. Pay particular attention to broken insulation and kinked cables.



Attention!

Replace damaged measurement cables immediately.

12.4 Fuse

A fuse is built into the device for protection.

The fuse is located in current-carrying conductor P+, which is connected directly to the power transistor for resistance measurement. If the fuse blows, resistance measurement is no longer possible.



Attention!

The fuse is permanently installed. The fuse may not be replaced by the user.

If the fuse blows, the battery tester must be sent to our repair service department or our respective foreign representative → 53.

It can only be assured that type-tested fuses with the correct blowing characteristics, current rating and breaking capacity are installed if replacement is conducted by our repair service department or our respective foreign representative. At the same time, technical safety inspection is also conducted on the instrument.



Note

For service technicians:

Use only the specified type-tested fuse!

If fuses with other blowing characteristics, other current ratings or other breaking capacities are used, you and the operator are placed in danger and protective diodes, resistors and other battery tester components may be damaged.

The use of repaired fuses or short-circuiting the fuse holder is prohibited.

12.5 Accessories

No special maintenance is required for the accessories. Keep outside surfaces clean.

Use a slightly dampened cloth to clean the multimeter measurement cable set (KS29), the alligator clips (KY95-3), the Kelvin probes (Z227D), the rubber holster, the carrying strap and the carrying case.



Attention!

Avoid the use of cleansers, abrasives or solvents.



Attention!

Never touch or clean the conductive ends of the test probes!



Attention!

Never clean the power pack.

13 Service and Support

13.1 Product Support

If required please contact:

GMC-I Messtechnik GmbH

Product Support Hotline

Phone +49-911-8602-0

Fax +49 911-8602-709

e-mail support@gossenmetrawatt.com

13.2 Repair and Replacement Parts Service Calibration Center * and Rental Instrument Service

If required please contact:

GMC-I Service GmbH

Service Center

Beuthener Str. 41

90471 Nürnberg, Germany

Phone +49 911 817718-0

Fax +49 911-817718-253

e-mail service@gossenmetrawatt.com

Web www.gmci-service.com

This address is only valid in Germany.

Please contact our representatives or subsidiaries for service in other countries.

Competent Partner

GMC-I Messtechnik GmbH is certified in accordance with DIN EN ISO 9001.

Our **DAkkS calibration laboratory** is accredited by the Deutsche Akkreditierungsstelle GmbH (national accreditation body for the Federal Republic of Germany) under registration number D-K-15080-01-01 in accordance with DIN EN ISO/IEC 17025.

Accredited quantities: direct voltage, direct current value, direct current resistance, alternating voltage, alternating current value, AC active power, AC apparent power, DC power, capacitance, frequency and temperature.

We offer a complete range of expertise in the field of metrology: from test reports and factory calibration certificates right on up to DAkkS calibration certificates.

An on-site DAkkS calibration station is an integral part of our service department. If errors are discovered during calibration, our specialized personnel are capable of completing repairs using original replacement parts.

As a full service calibration laboratory, we can calibrate instruments from other manufacturers as well.

Our spectrum of offerings is rounded out with free test equipment management.

14 CE Declaration

The battery tester fulfills all requirements of applicable EU directives and national regulations. We confirm this with the CE mark. A factory calibration certificate or test report is included with the battery tester.



EU-KONFORMITÄTSERKLÄRUNG
DECLARATION OF CONFORMITY



Dokument-Nr / Document-no: 20-001a

Hersteller / Manufacturer: GMC-I MESSTECHNIK GMBH

Anschrift / Address: Südwestpark 15
D - 90449 Nürnberg

Produktbezeichnung / Product name: Batterieprüfgerät
Battery Tester

Typ / Type: METRACELL BT PRO

Artikel-Nr / Article no: B100A / B

Das bezeichnete Produkt stimmt mit den Vorschriften folgender Europäischer Richtlinien überein, nachgewiesen durch die vollständige Einhaltung folgender Normen:

The above mentioned product has been manufactured according to the regulations of the following European directives proven through complete compliance with the following standards:

Nr. / No.	Richtlinie	Directive
2014/53/EU	Bereitstellung von Funkanlagen - RED Richtlinie - Anbringung der CE-Kennzeichnung : 2020	Making available of radio equipment - RED Directive - Attachment of CE mark : 2020

Anforderungen an die Sicherheit gemäß 2014/35/EU

Safety requirements according to 2014/35/EU

EN/Norm/Standard	IEC/Deutsche Norm	VDE-Klassifikation/Classification
EN 61010-1 : 2010	IEC 61010-1 : 2011	VDE 0411-1 : 2011

Anforderungen an die elektromagnetische Verträglichkeit gemäß 2014/30/EU

Requirements for electromagnetic compatibility according to 2014/30/EU

Grundnorm / Generic Standard
EN 61326-1 : 2013

Nürnberg, den 19.02.2020

Ort, Datum / Place, date:



Geschäftsführung / managing director

Diese Erklärung bescheinigt die Übereinstimmung mit den genannten Richtlinien, beinhaltet jedoch keine Zusage von Eigenschaften. Die Sicherheitshinweise der mitgelieferten Produktdokumentationen sind zu beachten.

© GMC-I Messtechnik GmbH 2017. Vorlage: FC8F29a_v11.17. Date: 03 Steuerdaten Sparte TT.doc

15 Returns and Environmentally Sound Disposal

This instrument is subject to directive 2012/19/EC on Waste Electrical and Electronic Equipment (WEEE) and its German national equivalent implemented as the Waste Electrical and Electronic Equipment Act (ElektroG) on the marketing, return and environmentally sound disposal of electrical and electronic equipment. The instrument is a category 9 product (monitoring and control instrument) in accordance with ElektroG (German Waste Electrical and Electronic Equipment Act).



The symbol at the left indicates that this device and its electronic accessories must be disposed of in accordance with applicable legal regulations, and not together with household waste. In order to dispose of the device, bring it to a designated collection point or contact our product support department (☎ 53).

This instrument is also subject to directive 2006/66/EC on batteries and accumulators and waste batteries and accumulators and its German national equivalent implemented as the Battery Act (BattG) on the marketing, return and environmentally sound disposal of batteries and accumulators.



The symbol at the left indicates that batteries and rechargeable batteries must be disposed of in accordance with applicable legal regulations. Batteries and rechargeable batteries may not be disposed of with household waste. In order to dispose of the batteries or rechargeable batteries, remove them from the instrument and bring them to a designated collection point.

Separate disposal and recycling conserves resources and protects our health and the environment.

Current and further information is available on our website at <http://www.gossenmetrawatt.com> under the search terms "WEEE" and "environmental protection".

© GMC-I Messtechnik GmbH
Edited in Germany • Subject to change, errors excepted • PDF version available on the Internet

All trademarks, registered trademarks, logos, product designations and company names are the property of their respective owners.

 **GOSSEN METRAWATT**
GMC-I Messtechnik GmbH
Südwestpark 15
90449 Nürnberg • Germany

Phone: +49 911 8602-111
Fax: +49 911 8602-777
E-mail: info@gossenmetrawatt.com
www.gossenmetrawatt.com