

MAVOWATT 210

Three-phase Power and Energy Logger

3-447-112-03
2/5.22



Download
software
"Dran-View XP"

Contents

1	Safety Precautions	1
2	Applications	3
2.1	Intended Use / Use for Intended Purpose.....	3
2.2	Use for Other than Intended Purpose	3
2.3	Liability and Guarantee	3
2.4	Opening the Instrument / Repairs	4
3	Documentation	4
3.1	Identifiers.....	4
4	First Steps	5
5	The Instrument	6
5.1	Scope of Delivery	6
5.2	Optional Accessories.....	6
5.3	Instrument Overview.....	7
5.4	Relevant Standards.....	12
5.5	Technical Data	13
5.6	Characteristic Values.....	14
6	Installation	16
6.1	Unpacking the Instrument	16
6.2	Power Supply.....	16
6.3	Setting up the Connection to the Integrated Web Server	16
6.4	Accessing the Integrated Web Server.....	19
7	Integrated Web Server	20
7.1	Information Page.....	20
7.2	Setup Page	22
7.3	Data Page	30
7.4	Factory Settings Page	33
8	Operation	36
8.1	Switching on/off	36
8.2	Making Measurement Connections	36
8.3	Measurement	38
8.4	Start Monitoring	44
8.5	Stop Monitoring	45

8.6 Saving Measurement Results	45
8.7 Manage Recorded Data in Dran-View XP	45
9 Maintenance	48
9.1 Cleaning.....	48
9.2 Maintenance	48
9.3 Troubleshooting	48
9.4 Repair	48
9.5 Calibration.....	49
10 Contact, Support and Service	50
11 CE Declaration	51
12 Returns and Environmentally Sound Disposal.....	51

1 Safety Precautions

General

Observe this documentation, in particular all included safety information, in order to protect yourself and others from injury, and to prevent damage to the instrument.

- Carefully and completely read and adhere to these operating instructions. The document can be found at <http://www.gossenmetrawatt.com>. Retain this document for future reference.
- Use only the specified accessories (included in delivery or listed as optional) with the instrument.
- Carefully and completely read and adhere to the product documentation of the optional accessories. Retain these documents for future reference.
- Observe and comply with all safety regulations which are applicable for your work environment.

Handling

- The instrument may only be used as long as it's in good working order.
- Inspect the instrument before use. Pay particular attention to damage, broken insulation or kinked cables.
- Accessories and cables may only be used as long as they're fully intact. Inspect all cables and accessories before use. Pay particular attention to damage, broken insulation or kinked cables.
- If the equipment is used in a manner not specified in this reference guide, the protection provided by the equipment may be impaired. These safety precautions are repeated where appropriate throughout this manual.
- If the instrument or an accessory doesn't function flawlessly, remove it from operation and secure it against inadvertent use.
- If the instrument or accessory is damaged during use, e.g. through falling, remove it from operation and secure it against inadvertent use.

Operating conditions

- Do not use the instrument after long periods of storage under unfavorable conditions (e.g. humidity, dust or extreme temperature).
- Do not use the instrument after extraordinary stressing due to transport.
- The instrument must not be exposed to direct sunlight.
- Only use the instrument and the accessories in compliance with the specified technical data and under the specified conditions (ambient conditions, IP protection class, measuring category, etc.).
- Do not use the instrument in potentially explosive atmospheres.

- The instrument and the included accessories may only be used for the tests/measurements described in the instrument's documentation.

Electricity

- Installation, operation, and maintenance of this instrument must be performed by qualified personnel only.
- Qualified personnel who work on or near exposed energized electrical conductors must follow applicable safety related work practices and procedures including appropriate personal protective equipment.
- Connect the earth (ground) terminal first, before making any other connections.
- When connecting to electric circuits or pulse initiating equipment, open their related breakers. Do not install any connection of the instrument on live power lines.
- Connections must be made to the instrument first, then connect to the circuit to be monitored.
- Wear proper personal protective equipment, including safety glasses and insulated gloves when making connections to power circuits.
- Hands, shoes, and floor must be dry when making any connection to a power line.
- Make sure the instrument is turned off before connecting probes to the rear panel.

2 Applications

Please read this important information!

2.1 Intended Use / Use for Intended Purpose

MAVOWATT 210 is a 3-phase, bidirectional power and energy logger designed to identify and record power quality problems such as voltage dips, voltage sags, supply voltage surges and voltage interruptions with a resolution of 1/2 cycles in accordance with IEC 61000-4-30. Harmonics are recorded in accordance with IEEE 519-2014 / IEC 61000-4-7.

MAVOWATT 210 has three voltage and four current channels. The instrument can be used in single, two, and three phase monitoring applications. The fourth current channel can be used for monitoring the neutral or other current sources.

Being connected to MAVOWATT 210, voltage measurement cables with safety banana jack connectors and alligator clips are used for direct connection of all voltage measurement inputs rated at 600 VRMS max. When voltages greater than 600 VRMS are measured, potential transformers (PTs) or other transducers must be used.

Being connected to MAVOWATT 210, flexible AC current probes based on the Rogowski principle or hinged current transformers (CT) are used to measure AC current. The flexible probe allows current measurements on conductors that are hard to reach. Hinged current transformers allow easy installation in branch circuits.

Installation, operation, and maintenance of this instrument must be performed by qualified personnel only. Safety of the operator, as well as that of the instrument, is only assured when it's used for its intended purpose.

2.2 Use for Other than Intended Purpose

Using the instrument for any purposes other than those described in these instrument operating instructions is contrary to use for intended purpose.

2.3 Liability and Guarantee

Gossen Metrawatt GmbH assumes no liability for property damage, personal injury or consequential damage resulting from improper or incorrect use of the product, in particular due to failure to observe the product documentation. Furthermore, all guarantee claims are rendered null and void in such cases.

Nor does Gossen Metrawatt GmbH assume any liability for data loss.

2.4 Opening the Instrument / Repairs

The instrument may only be opened by authorized, trained personnel in order to ensure flawless, safe operation and to assure that the guarantee isn't rendered null and void. Even original replacement parts may only be installed by authorized, trained personnel.



Unauthorized modifications to the instrument are prohibited.

If it can be ascertained that the instrument has been opened by unauthorized personnel, no guarantee claims can be honored by the manufacturer with regard to personal safety, measuring accuracy, compliance with applicable safety measures or any consequential damages.

3 Documentation

3.1 Identifiers

The following identifiers are used in this documentation::

Identifier	Meaning
 Attention! Warning	Safety information that must be complied with.
 Note! Important	Important information which must be taken into consideration and complied with.
✓ Prerequisite	A condition etc. which must be fulfilled before a given action can be taken.
1. Procedural step	Steps of a procedure which must be completed in the specified order.
↳ Result	Result of a procedural step.
• Enumeration	Bullet lists
– Enumeration	
Figure 1: Caption	Description of the content of a figure.
Tabelle 1:	Description of the content of a table.
Footnote	Comment

4 First Steps

1. Read and adhere to the product documentation. In particular observe all safety information in the documentation, on the instrument and on the packaging.
 - ⇒ "Safety Precautions" 1
 - ⇒ "Applications" 3
 - ⇒ "Documentation" 4
2. Familiarize yourself with the instrument ⇒ 6.
3. Install the instrument ⇒ 16.
4. Configure the instrument via its integrated web server ⇒ 20.
5. Operate the instrument ⇒ 36.

5 The Instrument

5.1 Scope of Delivery

Please check for completeness of the set (product no. M840B):

- 1 MAVOWATT 210
- 1 Power pack (IP42)
- 4 Voltage leads with detachable alligator jaw safety clip assembly, maximum jaw opening 20 mm
- 3 Flexible AC current probe based on the Rogowski principle, 50–500 A, measuring head length 40 cm (product no. Z840A)
- 1 Ethernet cable
- 1 Software **Dran-View XP**
(available for download ⇒ "Download Dran-View XP to a Computer" )45)
- 1 Softcase

5.2 Optional Accessories

Some measurements necessitate optional accessories:

- 1 Flexible AC current probe based on the Rogowski principle, 50 – 500 A, measuring head length 40 cm (product no. Z840A)
- 1 Flexible AC current probe based on the Rogowski principle, 150 – 1500 A, measuring head length 40 cm (product no. Z840B)
- 1 Flexible AC current probe based on the Rogowski principle, 300 – 3000 A, measuring head length 40 cm (product no. Z840C)
- 1 Split core current transformer MAVOWATT 210 CT-H-5A with connection cable suitable for MAVOWATT 210; 600 V CAT III; 5 A; class 0.5; cable opening diameter 10 mm (product no. Z840J)
- 1 Split core current transformer MAVOWATT 210 CT-H-20A with connection cable suitable for MAVOWATT 210; 600 V CAT III; 20 A; class 0.5; cable opening diameter 10 mm (product no. Z840K)
- 1 Split core current transformer MAVOWATT 210 CT-H-50A with connection cable suitable for MAVOWATT 210; 600 V CAT III; 50 A; class 0.5; cable opening diameter 10 mm (product no. Z840L)

5.3 Instrument Overview

5.3.1 Front

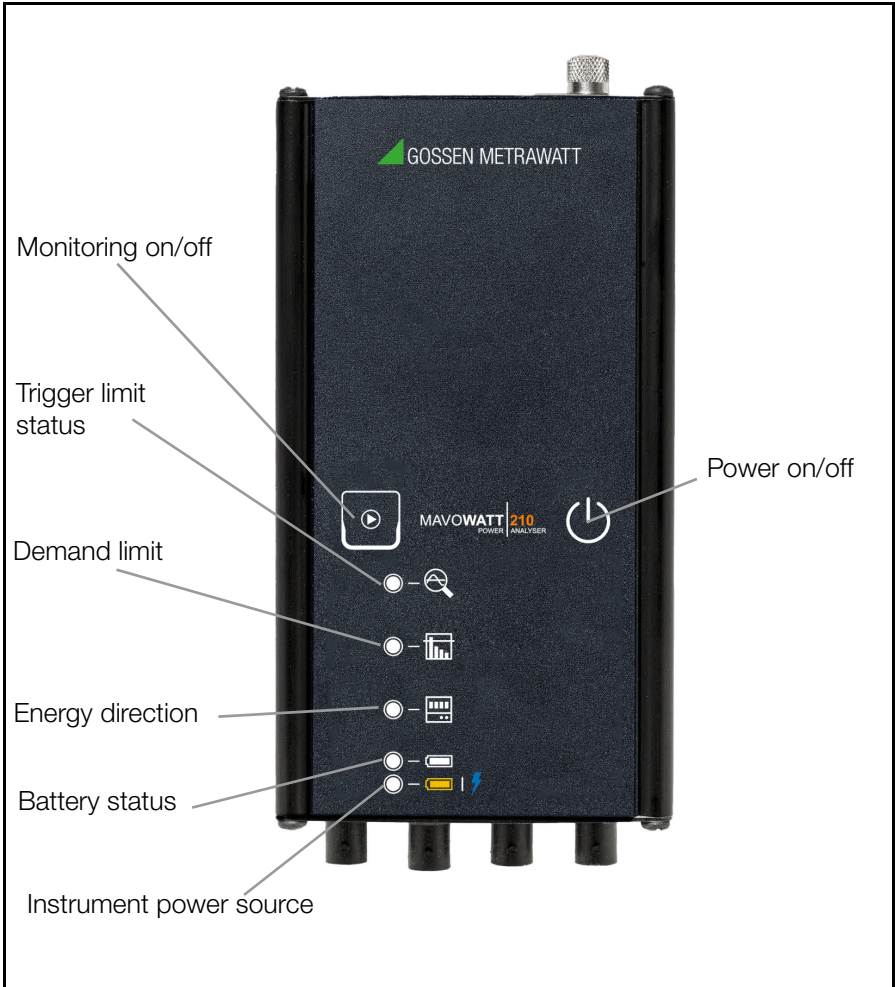

Figure 2: Front Panel

5.3.2 Top

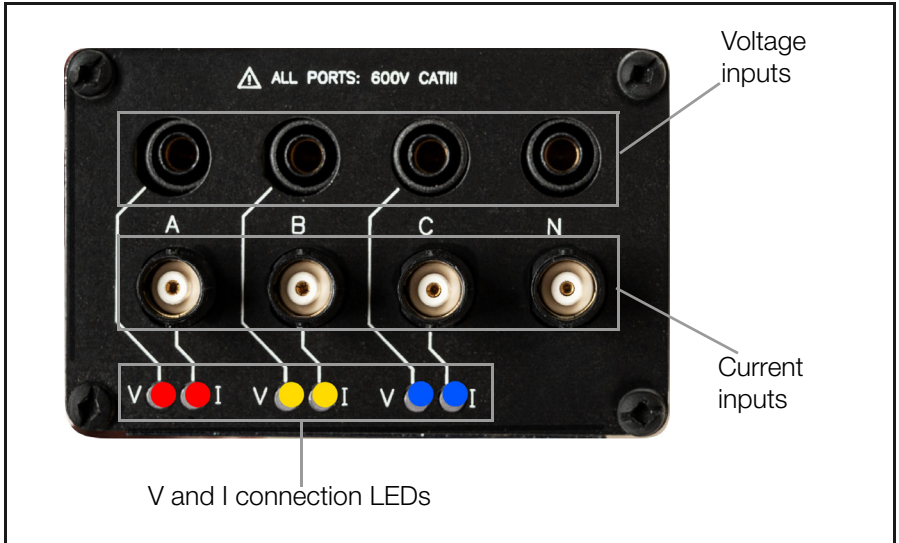

Figure 3: Top of instrument

5.3.3 Bottom

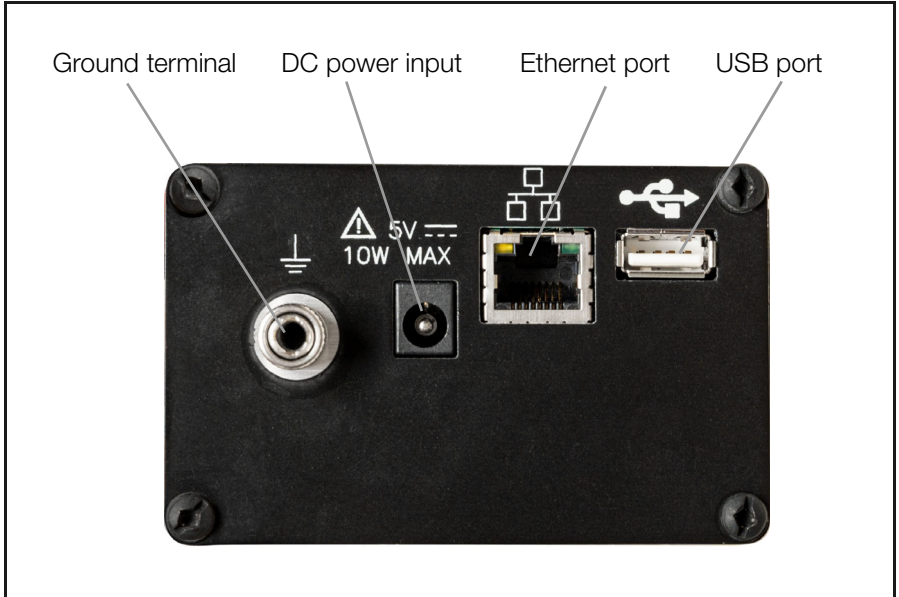









Figure 4: Bottom of instrument

5.3.4 Icons, Buttons and Indicators

Icon/Button/Indicators	Description
	<p>Power on/off</p> <p>Press to turn the instrument on. Press to turn the instrument off.</p>
	<p>Monitoring on/off</p> <p>Press and hold for approximately 5 seconds until a beep is heard to turn monitoring on. Press and hold for approximately 5 seconds until a beep is heard to turn monitoring off.</p>
	<p>Trigger limit status</p> <p>LED off: Monitoring off LED green: Monitoring limits within trigger limit LED red: Monitoring limits outside of trigger limits</p>
	<p>Demand limit</p> <p>LED green: Under demand limit LED red: Over demand limit</p>
	<p>Energy direction</p> <p>LED red: Consuming energy LED green: Producing energy</p>
	<p>Battery status</p> <p>LED red: Battery depleted LED yellow: Battery charging/discharging LED green: Battery completely charged</p>
	<p>Instrument power source</p> <p>LED green: Instrument powering up LED blue: Operating on external power source LED yellow: Operating on internal battery</p>

5.3.5 LED Indicators of Voltage (V) and Current (I) Connection LEDs

V and I connection LEDs are color coded to indicate the status of channels A, B, C for voltage and current.

LED Indicators of V and I Connection LEDs		
Indicator		Description
Red: Channel A Yellow: Channel B Blue: Channel C	LED lights up permanently in the channel color	Voltage or current applied
	LED flashes in the channel color	No voltage or current applied
	LED flashes red while monitoring is active	Voltage sequence error (if enabled)



Note!

LED colors can be changed in the instrument setup, see ⇨ "Instrument Setup" 26.

5.3.6 Measurement Cable Set, Voltage Leads



Figure 5: Voltage leads

5.3.7 Flexible AC Current Probe Based on the Rogowski Principle

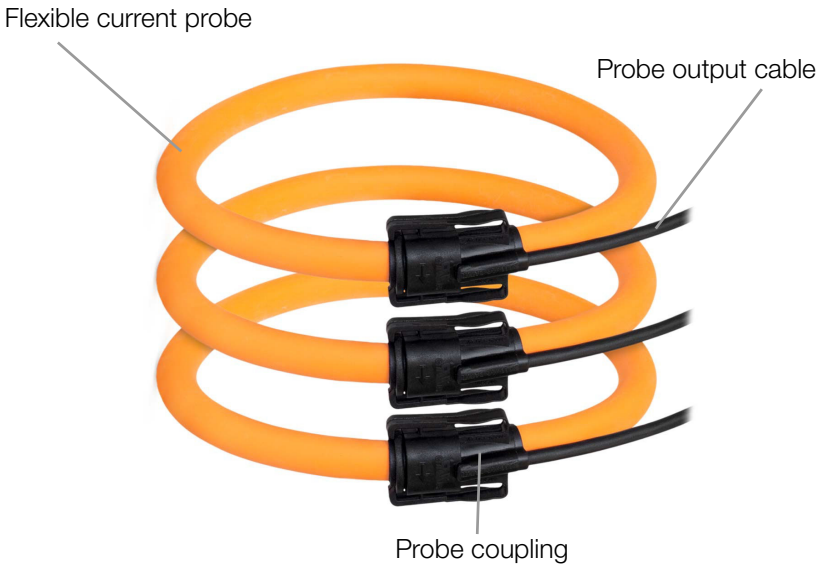

Figure 6: Flexible AC current probes based on the Rogowski principle

5.3.8 Symbols on the instrument and the included accessories:



Warning concerning a point of danger
(attention, observe documentation!)



Double insulation (protection category II)



AC



DC



Ground terminal



European conformity marking



The device may not be disposed of with household trash
⇒ "Returns and Environmentally Sound Disposal" 51.

5.4 Relevant Standards

The instrument has been manufactured and tested in accordance with the following safety regulations:

EN 61326	Class A, Electromagnetic Compatibility - Electrical equipment for Measurement, Control and Laboratory use
CISPR 11	Class A Limits Of Radio Disturbance and Immunity Measuring Apparatus
EN 61000-4-2	Electromagnetic compatibility (EMC) – Part 4-2: Testing and measurement techniques – Electrostatic discharge immunity test
EN 61000-4-3	Electromagnetic compatibility (EMC) – Part 4-3: Testing and measurement techniques - Radiated, radio-frequency, electromagnetic field immunity test
EN 61000-4-4	Electromagnetic compatibility (EMC) – Part 4-4: Testing and measurement techniques - Electrical fast transient/burst immunity test
EN 61000-4-5	Electromagnetic compatibility (EMC) – Part 4-5: Testing and measurement techniques – Surge immunity test

EN 61000-4-6	Electromagnetic compatibility (EMC) – Part 4-6: Testing and measurement techniques – Immunity to conducted disturbances, induced by radio-frequency fields
DIN EN 60529 / IEC 60529	Degrees of protection provided by enclosures (IP Code)
EN 61010-1	Safety Requirements of Electrical Equipment for Measurement, Control, and Laboratory Use

5.5 Technical Data

Power Supply	AC power supply	Range: 90 to 264 VAC, 47 to 63 Hz Consumption: 15 W max
	Internal Battery	Rechargeable lithium ion rechargeable battery 3.6 V, 7.2 Ah
		Run time: 7 hours (typical) Charge time: 15 hours (typical)
Ambient Conditions	Operating temperature	0 ... +45 °C
	Storage temperature	-15 ... +55 °C
	Elevation	max. 2000 m
	Relative humidity	5% to 95%, no condensation allowed
Electrical Safety	Protection category	CAT II
	Pollution degree	2
Measurement	Inputs	600 VRMS
	Measuring category	CAT III
	Pollution degree	2
Mechanical Design	Protection	Housing: IP50 per DIN EN 60529 / IEC 60529 (vertical position)
	Housing (W × H × D):	Approx. 6.4 × 8.9 × 18.8 cm
	Weight	Approx. 0.64 kg

Data Interfaces	Ethernet	10 Mbit/s
	USB	2.0
	Protocols	Modbus, BACnet®
Internal Memory	Storage capacity	8 GB

5.6 Characteristic Values

General	Sampling frequency	32 ksps (recorded and real-time meters), 128 samples per cycle (periodic waveform snapshots)
	Sag/dip, swell trigger resolution	1-cycle (uses IEC 61000-4-30 Class S methods)
Voltage	Range	90 to 600 VRMS CATIII
	Accuracy	90 VRMS to 600 VRMS = $\pm 0.1\%$, <90 VRMS = 0.5%
	Connections	4 safety banana voltage inputs - 3-phase voltage and 1 neutral/reference
Current	Input	0.333 VRMS full scale, Connections: BNC
	Accuracy	$\pm 0.1\%$ + probe
Frequency	Range	50 Hz = 45 Hz to 55 Hz, 60 Hz = 55 Hz to 65 Hz
	Accuracy	50/60 Hz: ± 0.001 Hz

Energy Parameters	(True/Active) energy (P)	0.1%
	Reactive energy (Q)	0.1%
	Apparent energy (S)	0.1%
	Fundamental active energy (P)	0.2%
	Fundamental reactive energy (Q)	0.2%
	Fundamental apparent energy (S)	0.2%
	Demand	0.2%
Power Parameters	Power (P)	0.2%
	Reactive power (Q)	0.2%
	Apparent power (S)	0.2%
	Fundamental active power (P)	0.2%
	Fundamental reactive power (Q)	0.2%
	Fundamental apparent power (S)	0.2%
	Power factor	±0.001%

6 Installation

6.1 Unpacking the Instrument

1. Carefully remove instrument and accessories from the packaging.
2. Check delivery for completeness and possible damage.
3. In case of detected damages, hidden defects and short deliveries, document type and scope and contact the manufacturer or supplier immediately.
4. Keep packing material for further transport.

6.2 Power Supply

The instrument can be powered via an AC power source or by an internal rechargeable battery.

The instrument will always operate on the AC power source (when available) and is designed to do so regardless of the state of charge of the battery.



Attention!

Always set the power switch to the **Off** position before connecting or disconnecting the input power cable.



Note!

Operation of the MAVOWATT 210 from an AC voltage source other than the rated voltage input stated on the instrument nameplate can cause damage to the instrument.



Note!

Always charge the battery fully before using the instrument.

1. Connect the AC adapter/battery charger plug to the DC input of the instrument.
2. Connect the appropriate power cord for the voltage rating of the instrument to the AC adapter/battery charger.
3. Plug the AC adapter into an AC power source.
 - ↳ The indicator LED on the AC adapter lights up green.
The instrument is supplied with AC power.

6.3 Setting up the Connection to the Integrated Web Server

The MAVOWATT 210 has an integrated web server for configuring the instrument and real time data checking (remote control).

During set up, the MAVOWATT 210 has to be connected directly to a computer (peer-to-peer connection via RJ-45 cable). It must then be configured for the network it is to be used in.

After set up, the web server can be accessed from any device that is connected to the same network (and identical IP range) and has a web browser, e.g. a computer or tablet.

6.3.1 Connecting Instrument via Wired Ethernet Connection

Factory default network settings	
IP Address	192.168.0.40
Username	admin
Password	Dranetz

1. Connect an RJ-45 Ethernet cable between your computer and the Ethernet port at the rear panel of the instrument.
2. Connect the power source at the rear panel of the instrument.
3. Power on the computer.
4. Press **Power on/off** on the top panel on the instrument.
The instrument is turned on.
5. Change the computer's IP address to be on the same network as MAVOWATT 210's default IP address (192.168.0.xxx). This involves changing the IP address properties of your computer. For more information, refer to the documentation of your computer.
6. Open a web browser and enter the default IP address into the address bar:
http://192.168.0.40
The login window is displayed.



Figure 7: Windows login

7. Enter the default Username: **admin**

8. Enter the default Password: **Dranetz**

The username and password are case-sensitive and must be entered as shown.

**Note!**

Change the default password on first login to prevent unauthorized access.

9. Click **OK**.

The MAVOWATT 210 start page is displayed.

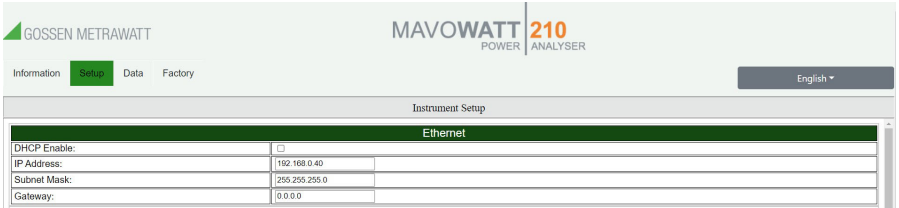

Figure 8: Start page web server

6.3.2 Configuring the Integrated Web Server's Network Access

✓ The instrument is connected to a computer via wired Ethernet connection. The MAVOWATT 210 start page is displayed. ⇨ "Setting up the Connection to the Integrated Web Server" 16.

1. Open **Setup/Instrument Setup/Ethernet**.

2. Assign a fixed IP address: In the field **IP Address**, enter the IP address of the network your instrument is to be used in.
or

Enable dynamic IP address assignment: Check **DHCP Enable**.

3. In the field **Subnet Mask** enter a valid subnet mask for the network being used. The default network subnet mask is 255.255.255.0.

4. In the field **Gateway** enter a valid gateway for the network being used.

↳ The IP address is assigned.

**Note!**

Change the default password on first login to prevent unauthorized access.

5. Disconnect the RJ-45 Ethernet cable from your computer.

6.4 Accessing the Integrated Web Server

- ✓ The integrated web server's IP address has been configured ⇒ "Setting up the Connection to the Integrated Web Server" 16.
You have a device (e.g. tablet or PC) that is connected to the network that the MAVOWATT 210 has been configured for previously.
You know the IP address you have configured for the MAVOWATT 210 web server. (If you activated DHCP, you must determine the assigned IP address. Refer to network scanning tools or your network administrator for this.)
1. Connect the MAVOWATT 210 with the network it is configured for using an RJ-45 cable. The Ethernet port of the MAVOWATT 210 is at the rear panel.
 2. Connect the power source at the rear panel of the MAVOWATT 210.
 3. Press **Power on/off** on the top panel on the MAVOWATT 210.
The MAVOWATT 210 is turned on.
 4. Open a web browser on the device (e.g. tablet or PC) that is connected to the same network.
 5. Enter the IP address of the MAVOWATT 210 in the address bar of the browser.
The MAVOWATT 210 information page is displayed.

The screenshot displays the MAVOWATT 210 web interface. At the top, there is a navigation menu with 'Information', 'Setup', 'Data', and 'Factory' tabs. The 'Information' tab is active. The main content area is titled 'Instrument Status' and contains a table of system information. Below this, there are sections for 'Communication Status', 'Clock Status', and 'Modules'. A 'Turn On Monitoring' button is visible at the bottom right of the information table.

Instrument Status	
Model	MAVOWATT 210
Serial #	MWXPKRA001
Version	V 01.01.067
OS Information	Kernel: 4.19.97-10.D-1.1.68-GB
Survey Name	Survey
Monitoring Status	Off
Active Database File	(null)
Power Source	Line
Charging	Yes
Battery Level	63%
Language	English
Communication Status	
IP Address	192.168.0.40
MAC Address	08:27:eb:ef:fd:4c
WiFi IP Address	
Clock Status	
Current Time (Local)	22/01/13 10:20:52
Current Time (UTC)	22/01/13 10:20:52
Modules	
Measurement	PMU Device driver
UI	RGB User interface
Expansion	

[Turn On Monitoring](#)

Figure 9: Information page

7 Integrated Web Server

The MAVOWATT 210 has an integrated web server for configuring the instrument and real time data checking.

During set up, you have to set up the instrument for access to your network (see ⇒ "Setting up the Connection to the Integrated Web Server" 16). You can now access the web server at any time from any device that is connected to the same network (and identical IP range) and has a web browser, e.g. a computer or tablet.

Configure the instrument according to your needs. All parameters are described in this chapter.

7.1 Information Page

When connecting to MAVOWATT 210, the information page is displayed.

The screenshot shows the web interface for the MAVOWATT 210. The top navigation bar includes 'Information', 'Setup', 'Data', and 'Factory'. The main content area is titled 'Instrument Status' and contains the following data:

Instrument Status	
Model	MAVOWATT 210
Serial #	MVXXPORA001
Version	V 01.01.067
OS Information	Kernel 4.19.97-10-E-1.1.66-GB
Survey Name	Survey
Monitoring Status	Off
Active Database File	(null)
Power Source	Line
Charging	Yes
Battery Level	63%
Language	English
Communication Status	
IP Address	192.168.0.40
MAC Address	b8:27:eb:ef:d2:4c
WiFi IP Address	
Clock Status	
Current Time (Local)	22/01/13 10:20:52
Current Time (UTC)	22/01/13 10:20:52
Modules	
Measurement	PMU Device driver
UI	RGB User interface
Expansion	

At the bottom of the page, there is a green button labeled 'Turn On Monitoring'.

Figure 10: Information page

Menu	Submenu	Description
Instrument Status	Model	Product name
	Serial #	Instrument serial number
	Version	Software version
	OS Information	OS information
	Survey Name	Name of survey
	Monitoring Status	Monitoring status
	Active Database File	Name of active database file
	Power Source	Selected power source
	Charging	Charging status
	Battery Level	Charging level of the battery
	Language	Selected language
Communication Status	IP Address	IP address of the instrument
	MAC Address	MAC address of the instrument
	WIFI IP Address	WIFI IP address ¹
Clock Status	Current Time (Local)	Local current time
	Current Time (UTC)	Current time UTC
Modules	Measurement	
	UI	
	Expansion	
Button Turn On Monitoring	Click to turn monitoring on.	
Button Turn Off Monitoring	Click to turn monitoring off.	

¹ Feature currently not available



Note!

When monitoring is on, the monitoring and instrument settings are “view only” and cannot be modified until monitoring is turned off.

7.2 Setup Page

7.2.1 Survey Setup

1. Select **Setup** > **Survey Setup** to view or change the current monitoring settings of the instrument.



Note!

The survey settings can only be modified if monitoring is off. If monitoring is on, you will receive a warning that the survey settings are "view only".

General		
Survey Name	Survey	<small>(30 characters (alpha, numbers, ...))</small>
Nominal Frequency	50 Hz	
Wiring Configuration	Three-Phase Vlg	
Enable Monitor On Power Up	<input type="checkbox"/>	
Pre-trigger Cycles	100	<small>(Smaller than 'Start Trigger Cycles')</small>
Total Trigger Cycles	50	<small>(0-600 Cycles)</small>
Voltage		
Nominal	120	<small>(00 v rms - 600 v rms)</small>
PT Ratio Primary	11	<small>(1-40000)</small>
PT Ratio Secondary	11	<small>(1-40000)</small>
Sequence Error Enable	<input type="checkbox"/>	
Enable V Limits	<input type="checkbox"/>	
High Threshold %	105	<small>(100% - 200.00%)</small>
Low Threshold %	95	<small>(7% - 120%)</small>
Input Order	A-B-C	
Current		
Nominal	5	<small>(1 v rms - 40000 v rms)</small>
Probe Type	Custom	
Current Probe Full Scale (Irms)	20	<small>(00 mV rms - 7.1E+10000 when Probe Type = Custom)</small>
CT Ratio Primary	5	<small>(1-40000)</small>
CT Ratio Secondary	5	<small>(1-40000)</small>
Enable I Limits	<input type="checkbox"/>	
High Threshold %	300	<small>(100%+)</small>

Figure 11: Survey setup

Menu	Submenu	Description
General	Survey Name	Enter a name (up to 48 characters) that describes your survey. This name will be included in the name of the data file recorded.
	Nominal Frequency	Dropdown selection: – 50 Hz – 60 Hz
	Wiring Configuration	Dropdown selection: – Single Phase – Split Phase – Three-Phase Wye – Three-Phase Delta 2 probes – Three-Phase Delta 3 probes
	Enable Monitor On Power Up	Checkbox enabled: If the instrument resets, monitoring will be re-enabled upon restart if monitoring was previously on.
	Pre-trigger Cycles	Number of pre-trigger RMS points (in cycles) to record when exceeding the voltage or current trigger limits. Must be less than the total trigger cycles.
	Total Trigger Cycles	Total number of RMS points (in cycles) to record when exceeding the voltage or current trigger limits. Entry range: 0 – 600 cycles

Voltage	Nominal	Nominal voltage Settable range: 90 – 600 VRMS
	PT Ratio Primary	PT primary (if applicable) Settable range: 1 – 65535
	PT Ratio Secondary	PT secondary (if applicable) Settable range: 1 – 65535
	Sequence Error Enable	Checkbox enabled: Enables connection panel LED notification of a voltage sequence/connection error. The LEDs will flash red if enabled and a voltage sequence error exists.
	High Threshold %	Voltage high trigger limit Settable range: 100 – 500% of the nominal voltage setting
	Low Threshold %	Voltage low trigger limit Settable range: 0 – 100% of the nominal voltage setting
	Input Order	Dropdown selectable: <ul style="list-style-type: none"> – A-B-C (default) – A-C-B – B-A-C – B-C-A – C-A-B – C-B-A Corrects for voltage wiring mistakes.

Current	Nominal	Nominal current for use with the current threshold settings. Settable range: 1 – 65535 IRMS
	Probe Type	Pull down list of available flex and hinged probe types. Select the probe used or custom for probes not listed.
	Current Probe Full Scale (IRMS)	Set only for the custom probe type (above). Full scale of the CT's being used. Settable range: 1 – 3000 (0.333 mVRMS = x amps, x is the full scale)
	CT Ratio Primary	CT primary (if applicable). Settable range: 1 – 65535
	CT Ratio Secondary	CT secondary (if applicable). Settable range: 1 – 65535
	High Threshold %	Current high trigger limit. Settable range: 100 – 500% of the nominal current setting
	Low Threshold %	Current low trigger limit. Settable range: 0 – 100% of the nominal current setting
	Input Order	Dropdown selectable: <ul style="list-style-type: none"> – A-B-C (default) – A-C-B – B-A-C – B-C-A – C-A-B – C-B-A Corrects for current wiring mistakes.
Energy	Enable	Checkbox enable/disable
	Demand Interval Min	Settable range: 1 minute – 1440 minutes
	Demand Sub-Interval	Settable range: 1 minute – 1440 minutes
	Demand Limit	When exceeded the Demand LED on the front panel will change to red to indicate the programmed limit has been exceeded.

Journal / Snapshot	Journal Enable	Checkbox enable/disable.
	Journal Interval Sec.	Journal interval entered in seconds. Value entered: ≥ 1 second
	Snapshot Enable	Checkbox enable/disable
	Snapshot Interval Sec.	Snapshot interval in seconds. Value entered: ≥ 60 seconds
Button Submit Changes	Click to save the settings.	
Button Discard Changes	Click to discard the settings.	

7.2.2 Instrument Setup

1. Select **Setup > Instrument Setup** to view or change the current instrument setup.



Note!

The instrument settings can only be modified if monitoring is off. If monitoring is on, you will receive a warning that the survey settings are "view only".

Figure 12: Instrument setup

Menu	Submenu	Description
Ethernet	DHCP	Checkbox enabled: An IP address will be automatically assigned to the instrument by the network. The IP address assigned can be viewed in the Home/Instrument Status page.
	IP Address	Instrument static IP address: Enter a valid IP address for the network being used. (The default static IP address is 192.168.0.40)
	Subnet Mask	Network subnet mask: Enter a valid subnet mask for the network being used. (The default is 255.255.255.0)
	Gateway	Network gateway setting: Enter a valid gateway for the network being used.
Date and Time	Date and Time	Click in the date/time entry area to open up a dialog box to enter the local time and date. Click the Change Date/Time button when completed.
	DST Enable	Checkbox enable/disable: Enable or disable Daylight Savings Time .
	Time Zone Offset	Dropdown: Select the local time zone.
Input Channels	Channel A Color	Dropdown list: Change the color of the connector panel LEDs to match the circuit's wire colors. Default channel A LED color is red.
	Channel B Color	Dropdown list: Change the color of the connector panel LEDs to match the circuit's wire colors. Default channel B LED color is yellow.
	Channel C Color	Dropdown list: Change the color of the connector panel LEDs to match the circuit's wire colors. Default channel C LED color is blue.

Database	Max DB File Seconds	Set the duration of the data file in hours, days, weeks, or months from a drop-down list. The default setting is 31 days. You can also enter a custom setting in seconds (< 1 hr). This setting is how long the instrument will record until a new data file is automatically created. A new data file will automatically be created when the duration is exceeded.
	Max DB Keep	Set the duration of time that the data file will be retained in memory in days, weeks, months, or years from a drop-down list. You can also enter a custom setting in minutes. This setting is the length of time that the data file is retained in instrument memory before it is marked for deletion from the database automatically. Data files older than this setting will be automatically deleted.
BACnet	BACnet Enable	Checkbox enable/disable
	BACnet Device ID	Enter a valid BACnet device ID for the instrument.
Modbus TCP	Modbus Enable	Checkbox enable/disable
	Modbus Port	Enter a valid modbus port. The default Modbus port is 502.
Button Submit Changes	Click to save the settings.	
Button Discard Changes	Click to discard the settings.	



Note!

The time and date of data stored in the instrument's database is recorded in UTC time. By setting the local time zone offset, the data will appear in MAVOWATT 210 and **Dran-View XP** in the local time zone.

7.2.3 Downloading Configuration

Downloading the instrument settings allows you to store a settings template for your surveys that can be uploaded back into the instrument for future use.

1. Select **Setup > Download Config** to download the instrument settings to your computer.
2. Select **CfgActive.json** to download the current instrument settings to your computer via your web browser's file download feature.
3. When prompted, select **Save** or **Save as** in your web browser.

↳ The file will be stored on your computer.

It will be named **Survey Name.json**, where Survey Name is the survey name that you programmed. Once saved to your computer, this file can be renamed.

7.2.4 Uploading Configuration

Uploading settings files to the instrument proceeds in four steps. Each step is highlighted in green as you progress through the process.



Note!

It is recommended to save the default **CfgActive.json** file from the instrument before uploading a setup file ⇒ "Downloading Configuration" 29.

The screenshot shows the 'Config Upload' interface. At the top, there are navigation tabs for 'Information', 'Setup', 'Data', and 'Factory', with 'Setup' selected. The title 'Config Upload' is centered. Below it is a table titled 'Update Configuration with File' with four columns: Step #, Name, Description, and Status.

Step #	Name	Description	Status
1	File Selection	Select the configuration file to be uploaded to the instrument. It should be a file named CfgActive.json. Press the BROWSE button to locate the CfgActive.json file.	BROWSE
2	Upload	Send the selected file to the instrument. This will take several seconds. Press the UPLOAD button to the right when you are ready to begin.	UPLOAD
3	Update	Press the UPDATE button to the right to begin.	UPDATE
4	Complete	You're done with the Config Upload. You don't need to do anything else. From here you can continue on with normal operation with this site. You can use the Information-Instrument Status menu item to confirm that the instrument is receiving the updated configuration.	

Figure 13: Upload configuration

1. Select **Setup > Upload Config** to upload a settings file that was previously downloaded.
The row **File Selection** is highlighted.
 2. Click **BROWSE** to path to the configuration file to upload.
 3. Select the file and click **Open**.
The row **Upload** is highlighted.
 4. Click **UPLOAD** to transfer the configuration file to the instrument.
The row **Update** is highlighted.
 5. Click **UPDATE** to save the configuration information into the instrument.
The row **Complete** is highlighted.
- ↳ Uploading the configuration has been successfully completed.

7.3 Data Page

7.3.1 Real-Time Measurements

Real-time measurements are updated about every 5 seconds. The table below lists the real-time parameters displayed and their units.

1. Select **Data** > **Meters** to view the real-time metering information.

Energy		
Description	Units	Channel (wiring dependent)
True Energy	Whr	A, B, C
Reactive Energy	VAhr	A, B, C
Apparent Energy	VAhr	A, B, C
True Energy (Fundamental)	Whr	A, B, C
Reactive Energy (Fundamental)	VAhr	A, B, C
Apparent Energy (Fundamental)	VAhr	A, B, C

Power		
Description	Units	Channel (wiring dependent)
Frequency	Hz	A, B, C
RMS Voltage	VRMS	A, B, C
RMS Current	IRMS	A, B, C
True Power	W	A, B, C
Apparent Power	VA	A, B, C
Reactive Power	VAr	A, B, C
Power Factor		A, B, C
Voltage THD	%	A, B, C
Current THD	%	A, B, C
RMS Voltage (Fundamental)	VRMS	A, B, C
RMS Current (Fundamental)	IRMS	A, B, C
True Power (Fundamental)	W	A, B, C
Apparent Power (Fundamental)	VA	A, B, C
Reactive Power (Fundamental)	VAr	A, B, C
RMS Voltage (1 sec avg)	VRMS	A, B, C
RMS Current (1 sec avg)	IRMS	A, B, C

RMS Voltage (10/12 cycle)	VRMS	A, B, C
RMS Current (10/12 cycle)	IRMS	A, B, C
Voltage Phase	Deg.	A, B, C
Current Phase	Deg.	A, B, C

Neutral		
Description	Units	Channel (wiring dependent)
Neutral RMS Current	IRMS	N
Neutral RMS Current (1 sec avg)	IRMS	N
Neutral RMS Current (10/12 cycle)	IRMS	N

Demand		
Description	Units	Channel (wiring dependent)
Peak Demand	W	A, B, C
Peak Reactive Demand	VA _r	A, B, C
Peak Apparent Demand	VA	A, B, C
Peak Demand (Fund.)	W	A, B, C
Peak Reactive Demand (Fund.)	VA _r	A, B, C
Peak Apparent Demand (Fund.)	VA	A, B, C

7.3.2 Downloading and Managing Data

The **List Files** page allows you to download data recorded by MAVOWATT 210 to your computer for analysis using Dran-View XP, and to also delete files.

1. Select **Data > List Files** to view the recorded data files in the instrument’s memory.

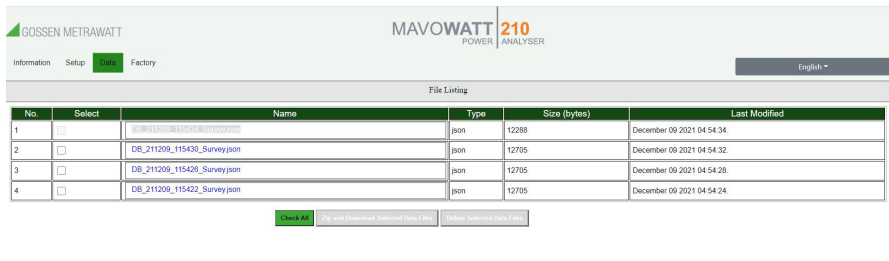

Figure 14: Data file listing

Download Data Files to a Computer

1. Check the file(s) to download or click **Check All** to select all data files.
2. Click **Zip and Download Selected Data Files** to download the selected files. The Zip feature will combine (zip and compress) multiple files into one file for downloading.
- ↳ MAVOWATT 210 will display a progress window, and when completed, your web browser will prompt you to open or save the zip file.
3. Click **Save** or **Save As** to save the file to your web browser's Download folder (name and location are browser-dependent).

Once the zip file has been downloaded, you can then move the file to another location on your computer, network, or transfer via email or FTP to another computer.

Unzip Data Files on a Windows Computer

1. Locate the downloaded zip file you want to unzip.
2. Right-click on the file and select **Extract All**.
3. Click **Browse** to choose or create the folder where the extracted data files will be saved.
4. Click **Extract** to save the MAVOWATT 210 files to the location chosen. Note that MAVOWATT 210 data files are of the file type ".json".
5. When the above is completed, the MAVOWATT 210 data is ready to be viewed by Dran-View XP.

Deleting Data Files from MAVOWATT 210's Memory

1. Check the file(s) to delete or click **Check All** to select all data files.
2. Click **Delete Selected Data Files**.
3. When prompted, click **OK** to delete the selected files or **Cancel** to abort.

7.4 Factory Settings Page

7.4.1 Instrument Firmware

Gossen Metrawatt GmbH continually provides updates to its products to enhance their capabilities and to correct known issues. These updates are available for download on our website after registration in myGMC:

<https://www.gmc-instruments.de/en/services/mygmc/>

The firmware version of your instrument can be found on the **Instrument Status** page. If the firmware posted on our website is newer than what is installed in your instrument, please download the firmware update. Follow the firmware installation instructions to update your instrument ⇨ "Firmware Updates" 📄33.

7.4.2 Firmware Updates

A firmware update wizard will guide you through the steps of the update process. Each step is highlighted in green as you progress through the process.

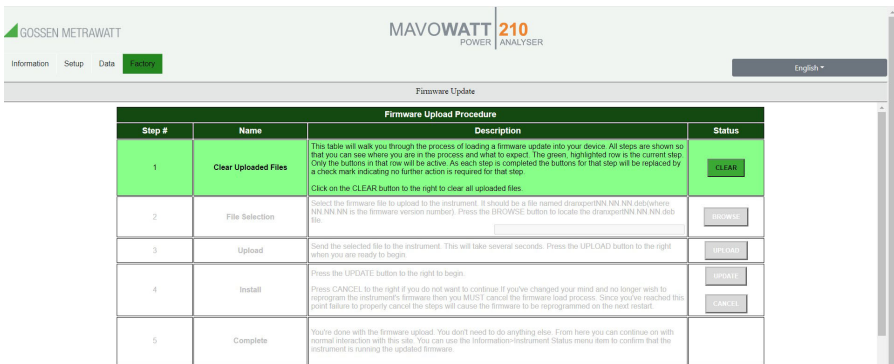

Figure 15: Firmware update

1. Select **Factory > Update Firmware** to update MAVOWATT 210's firmware.
2. Click the **Clear** button to clear previously updated firmware.
3. Click **Browse** to locate the firmware update file that you downloaded from the Gossen Metrawatt GmbH website. Note that MAVOWATT 210 firmware files have a '.deb' file extension. Select the firmware file and click **Open**.
4. Click the **Upload** button to upload the firmware update file to MAVOWATT 210.
5. Click the **Update** button to start the firmware update process or click **Cancel** to abort.
- ↳ When the firmware update process has completed, the last step will be highlighted in green.
6. Check the **Information > Status page** to verify that the version displayed matches the new version installed.

7.4.3 Restore Factory Defaults

There are three options to restore MAVOWATT 210's settings to its factory defaults.

1. Select **Factory**.
2. Select one of the three options:
 - **Restore Factory Default (Keep IP)**
Restores the factory settings but keeps the data and IP address settings as is (unchanged).
 - **Restore Factory Default with Data Purge (Keep IP)**
Restores the factory settings and purges all data, but keeps the IP address settings as is (unchanged).
 - **Restore All Settings to Factory Default (incl. IP)**
Restores all factory settings including the IP address, and also purges the data.



Note!

Depending on the selected option, instrument settings, recorded data, and/or the IP address will be deleted from the instrument.

You will be prompted to confirm that you would like to proceed.

3. Click **OK** to continue or click **Cancel** to abort.

7.4.4 Restart

Restarting will reboot the instrument, and when completed, the instrument will resume monitoring if monitoring was previously turned on. No settings or data files are lost when restarting.

1. To restart the instrument, select **Factory > Restart**.

7.4.5 Change Password

1. Select **Factory** > **Change Password**.

The screenshot shows the 'Security - Change Password' interface. At the top, there is a navigation bar with 'GOSSEN METRAWATT' on the left, 'MAVOWATT POWER 210 ANALYSER' in the center, and 'English' on the right. Below this is a sub-header 'Security - Change Password'. The main content area is divided into two sections: 'Login' and 'Change Password'. The 'Login' section has two input fields: 'Username' and 'Current Password', followed by a 'Login to Change Password' button. The 'Change Password' section has three input fields: 'New Password', 'Re-enter New Password', and 'Submit New Password'.

Figure 16: Change password

2. Enter the username and the current password in the **Login** field.
 3. Click **Login to Change Password**.
 4. Enter the new password in the fields **New Password** and **Re-enter New Password**.
 5. Click **Submit New Password**.
- ↳ The new password is set.



Note!

The username cannot be changed.

8 Operation

8.1 Switching on/off

Press **Power on/off** to turn the instrument on.

Press **Power on/off** again to turn the instrument off.

8.2 Making Measurement Connections



Attention!

Death, serious injury, or fire hazard could result from improper connection of this instrument. Read and understand the warnings in the beginning of this guide before connecting this instrument.



Attention!

To reduce the risk of fire, electric shock, or physical injury, it is strongly recommended that connections be made with all circuits de-energized and current carrying conductors fused. If it is necessary to make connections on energized circuits, these must be performed by qualified personnel ONLY with proper personal protective equipment.



Attention!

To avoid the risk of electric shock or burns, always connect the earth ground before making any other connections.



Attention!

Do not exceed the marked maximum ratings.

MAVOWATT 210 has three voltage and four current channels which can be used to measure a wide variety of circuit types. Refer to the appropriate connection diagram for the desired circuit type. ⇨ "Measurement" 38.

8.2.1 Connecting Voltage Measurement Cables to MAVOWATT 210

✓ The instrument is powered off.

1. Connect the alligator jaw safety clip to the voltage measurement cable (white cable to white clip; red, blue and yellow cable to black clip).
 2. Plug the banana jack connector of the voltage measurement cable to the voltage input of the instrument.
-

8.2.2 Connecting Voltage Measurement Cables to the Circuit to be Measured

Direct connection of all voltage measurement inputs are rated at 600 VRMS max. When measuring voltages greater than 600 VRMS, potential transformers (PTs) or other transducers must be used.

Voltage probes are connected to the individual source or load lines and are referenced to the return (common).

✓ The instrument is powered off.

1. Connect the alligator clips of the instrument to the circuit to be measured.

8.2.3 Connecting AC Current Probes to MAVOWATT 210

✓ The instrument is powered off.

1. Plug the probe output cable of the current probe to the current input of the instrument.

8.2.4 Connecting AC Current Probes to the Circuit to be Measured



Attention!

DO NOT use other probe types, including probes that use uninsulated connectors.



Attention!

DO NOT USE non-insulated current probe cores around a non-insulated wire. Probes of this type are designed for use around insulated wires only. Use only completely insulated probe cores with no exposed conductive areas of the core around non-insulated wires.



Attention!

DO NOT attempt to measure current in any circuit in which the circuit to ground voltage exceeds the insulation rating of the current probe (example: 600 VRMS max).



Attention!

Make sure the current probes are tightly closed. Keep mating surfaces clean and free from foreign matter.

**Attention!**

Use only probes that are rated 600 V CAT III or higher.

**Note!**

Do not locate the probe coupling close to other conductors carrying high current.

**Note!**

Be sure to connect the current probes with the arrow pointing towards the load or an erroneous power reading will result.

- ✓ The instrument is powered off.
- 1. Open the probe coupling and slip the measuring head over the conductor carrying the current to be measured.
- 2. Position the probe in such a way that
 - the arrow marking on the current probe points in the direction of current flow and towards the load,
 - the conductor is centered within the measuring head,
 - the measuring head forms a perfect circle.
- 3. Close the probe coupling such that it visibly and audibly snaps into place.
- 4. Select the applicable current probe settings in the **Survey Setup** of the instrument's web server → "Survey Setup" 22.

8.3 Measurement

MAVOWATT 210 can monitor the following power configurations:

- Single Phase
- Split Phase
- 3 Phase, Four Wire Wye
- 3 Phase, Three Wire Delta (2 or 3 probe)

8.3.1 Single Phase Measurement

When making single phase measurements, use channel A as shown below. The neutral is chosen as the reference for measurement purposes. You may optionally measure the neutral current by connecting a current probe to the neutral conductor and to the N channel current input.

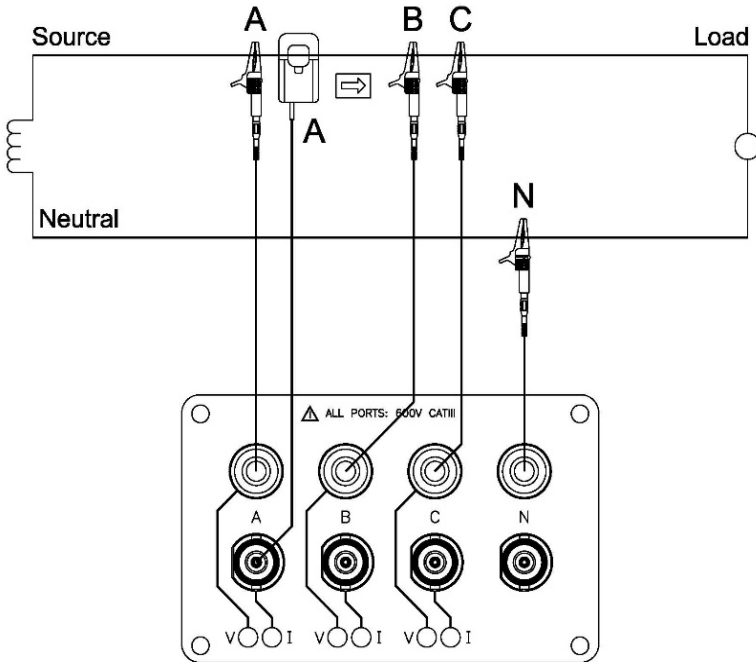

Figure 17: Single phase measurement

8.3.2 Split Phase Measurement

When making split phase measurements, use both channels A and C for voltage and current connections. The neutral is chosen as the reference for measurement purposes. You may optionally measure the neutral current by connecting a current probe to the neutral conductor and to the N channel current input.

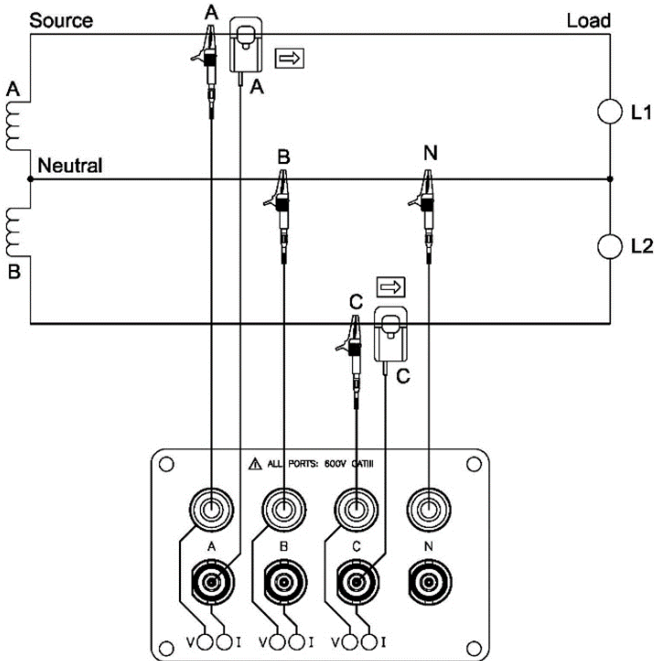

Figure 18: Split phase measurement

8.3.3 3 Phase Measurement, Four Wire Wye

Channels A, B, and C are connected to the voltage and current probes. The neutral is connected to common and is the reference for the three voltage channels. Note that the neutral current measurement is optional.

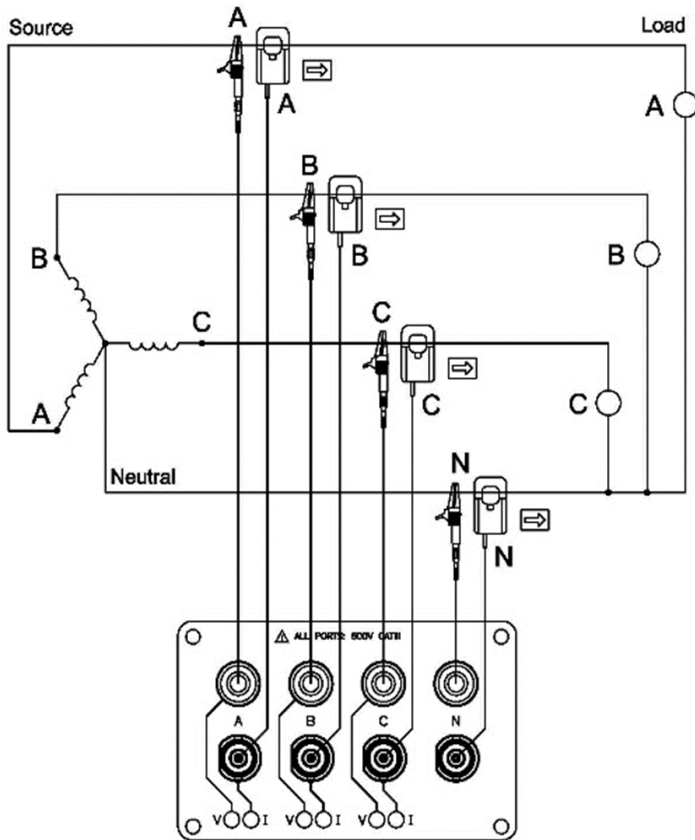

Figure 19: 3 Phase measurement, four wire wye

8.3.4 3 Phase Measurement, 2 Probe Delta

The figure below shows the 3 phase, 2 probe, 2 wattmeter delta connection using phase channels A-B-C.

The N channel is connected to phase B as the reference for measurement purposes.

Current probes are connected to measure line currents A and C.

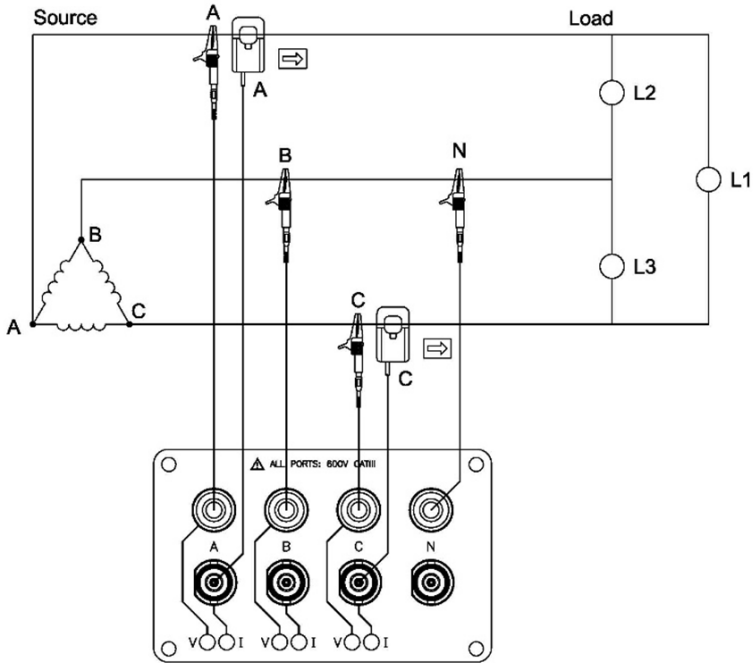

Figure 20: 3 Phase measurement, 2 probe delta

8.3.5 3 Phase Measurement, 3 Probe Delta

The figure below shows the 3 phase, 3 probe, 2 wattmeter delta connection using phase channels A-B-C.

The N channel is chosen as the reference and is connected to phase B for measurement purposes.

Current probes are connected to measure line currents A, B and C. Note that the B current probe is connected to measure the B phase current only and is not included as part of the power computations.

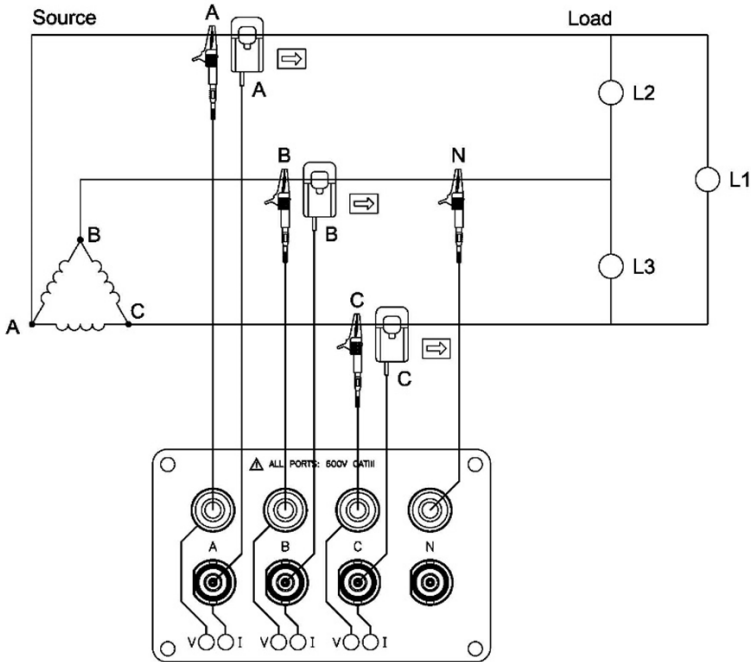

Figure 21: 3 Phase measurement, 3 probe delta

8.4 Start Monitoring

Monitoring can be started by using either the instrument's keypad or via the integrated web server.

8.4.1 Starting Monitoring via Instrument Keypad

- ✓ The measurement connections have been made.
 - ✓ The instrument is powered on.
1. Press and hold **Monitoring on/off** for approximately 5 seconds.
 - ↳ A beep is heard.
 - ↳ Monitoring is turned on.
 - ↳ The instrument's indicator LED **Monitoring Status** is active.

8.4.2 Starting Monitoring via Web Server

- ✓ The measurement connections have been made.
 - ✓ The instrument is powered on.
 - ✓ The connection to the integrated web server has been established.
1. Select **Information > Status** in the integrated web server.
 2. Click **Turn On Monitoring**.
 - ↳ Monitoring is turned on.

The screenshot shows the 'Instrument Status' page of the MAVOWATT 210 web interface. The page is organized into several sections with green headers:

- Instrument Status**:

Mode	MAVOWATT 210
Serial #	WXXXP0RAD01
Version	2.01.01.00
OS Information	kernel 4.10.97-10-E1-1.96-08
Survey Name	Survey
Monitoring Status	On
Active Database File	06_220119_103219_Survey
Power Source	Line
Charging	Yes
Battery Level	83%
Language	English
- Communication Status**:

IP Address	192.168.0.40
MAC Address	88:27:eb:ef:64:4c
WSN IP Address	
- Clock Status**:

Current Time (Local)	22/01/13 10:32:20
Current Time (UTC)	22/01/13 10:32:20
- Modules**:

Measurement	PMU Device driver
UI	USB User interface
Expansion	

A green button labeled 'Turn Off Monitoring' is located at the bottom center of the page.

Figure 22: Monitoring status information

8.5 Stop Monitoring

Monitoring can be stopped by using either the instrument's keypad or via the integrated web server.

8.5.1 Stop Monitoring via Instrument Keypad

- ✓ Monitoring is running.
- 1. Press and hold **Monitoring on/off** for approximately 5 seconds.
 - ↳ A beep is heard.
Monitoring is turned off.
The instrument's indicator LED **Monitoring Status** turns off.

8.5.2 Stop Monitoring via Web Server

- ✓ Monitoring is running.
- 1. Select **Information > Status** in the integrated web server.
- 2. Click **Turn Off Monitoring**.
 - ↳ Monitoring is turned off.

8.6 Saving Measurement Results

See ⇨ "Downloading and Managing Data" 31.

8.7 Manage Recorded Data in Dran-View XP

Dran-View XP is a software for power analysis with MAVOWATT 210 that makes it possible for energy experts to quickly and easily visualize and evaluate data pertaining to power quality and monitoring.

In order to view and analyze data recorded by MAVOWATT 210 with **Dran-View XP** software, you must first copy the MAVOWATT 210 data files to your computer. MAVOWATT 210 data files are stored in a json (JavaScript Object Notation) file format and have a ".json" file extension.

8.7.1 Download Dran-View XP to a Computer

In the user's personal area **myGMC** you can register your devices and download related software.

1. Go to the website <https://www.gmc-instruments.de/en/services/mygmc/>.
2. Create an account for the **myGMC** personal area.
3. Register your instrument in the **myGMC** personal area.
4. A download link for the Software **Dran-View XP** is provided in the **myGMC** personal area.
5. Click on the download link.
The software package **Dran-View XP** is downloaded.

6. Follow the instructions on your computer to install the **Dran-View** software package.

↳ Dran-View XP is installed on your computer.

8.7.2 Download Data Files from MAVOWATT 210 to a Computer via Web Server

1. Download data to a computer via the integrated web server ⇒ "Downloading and Managing Data" 31.

8.7.3 Download Data Files from MAVOWATT 210 to a Computer via USB Drive

✓ Monitoring is turned off.

1. Insert a USB drive into the USB port.

All data files from the instrument are being copied to the USB drive.

The 6 measurement input LEDs are flashing green while data is being transferred to the USB drive. The data transfer has completed when the measurement input LEDs stop flashing.

2. When the transfer is complete, remove the USB drive from the instrument.

3. Insert the USB drive into a USB port of the computer running **Dran-View XP**.

4. Copy the data files from the USB drive to your computer.

8.7.4 Open Data in Dran-View XP on a Computer

1. Start **Dran-View XP** on the computer.

Select **File** and then select **Open**.

2. Locate and select the data file of interest and select **Open**.

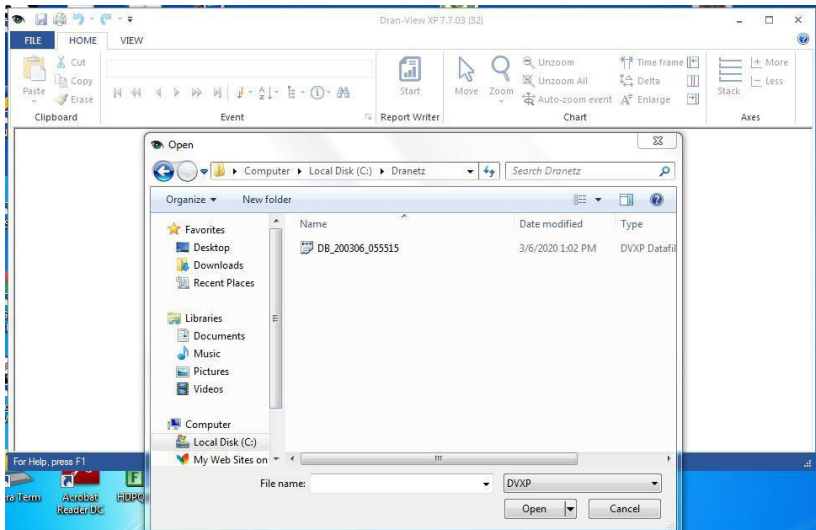

Figure 23: Opening data in Dran-View XP

↳ The data recorded by MAVOWATT 210 is displayed.

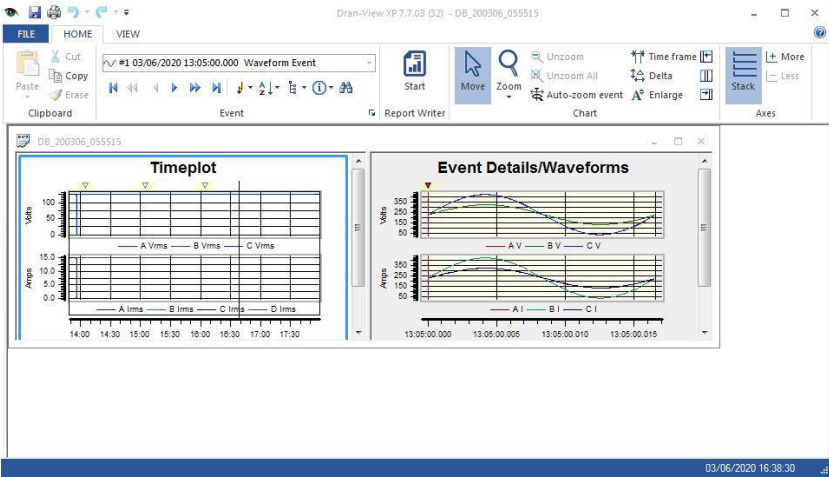

Figure 24: Displaying data in Dran-View XP

For a detailed description of **Dran-View XP** features, refer to the software documentation available after installation of **Dran-View XP**.

9 Maintenance

9.1 Cleaning



Attention!

Do not immerse.

Clean the instrument by wiping it gently with a damp, lint-free cloth. A mild detergent can be used if desired.

9.2 Maintenance

To ensure the accuracy of the instrument, the instrument must be calibrated at least once every 12 months. Calibration must be performed by the indicated Calibration Center in order to maintain the warranty ⇒ "Contact, Support and Service" 50.

9.3 Troubleshooting

In the following we list common problems that may occur during operation and suggest remedies for the elimination of simple faults. If the recommended procedures do not succeed, please contact our support. ⇒ "Contact, Support and Service" 50.

Problem	Remedy
The LED indicators remain dark after switching on.	Power supply by battery: – Check if the battery is charged.
	Power supply via AC adapter: – Check if the AC adapter/battery charger plug is firmly connected to the instrument.

9.4 Repair

The instrument is intended to be serviced only by authorized service personnel. Service procedures should only be performed by qualified technical personnel.

Battery replacement may only be performed by GMC-I Service GmbH ⇒ "Contact, Support and Service" 50.

9.5 Calibration

Using your device and the stressing it is subjected to in doing so may result in deviation from the specified levels of accuracy.

In the case of strict measuring accuracy requirements, as well as frequent stress (such as considerable climatic or mechanical stressing), we recommend a relatively short calibration interval of once per year. If this is not the case, a calibration interval of once every 2 to 3 years is sufficient as a rule.

For calibrations please contact GMC-I Service GmbH ⇨ "Contact, Support and Service" ☎50.

10 Contact, Support and Service

You can reach Gossen Metrawatt GmbH directly and uncomplicated, we have one number for everything!

Whether it's a support question, or individual desire, we answer every request at:

+49-911-8602-0

Monday–Thursday: 8:00 a.m. – 4:00 p.m.

Friday: 8:00 a.m. – 2:00 p.m.

You can also e-mail to:

info@gossenmetrawatt.com

Do you prefer support via e-mail?

Measuring and test
instruments:

support@gossenmetrawatt.com

Industrial equipment:

support.industrie@gossenmetrawatt.com

For repairs, replacement parts, and calibrations¹ please contact GMC-I Service GmbH:

+49-911-817718-0

service@gossenmetrawatt.com

www.gmci-service.com

Beuthener Str. 41

90471 Nürnberg

Germany



¹. DAkkS calibration laboratory per DIN EN ISO/IEC 17025.

Accredited at the Deutsche Akkreditierungsstelle GmbH under registration no. D-K-15080-01-01.

11 CE Declaration

The instrument fulfills all requirements of applicable EU directives and national regulations. We confirm this with the CE mark. The CE Declaration of Conformity is available upon request.

12 Returns and Environmentally Sound Disposal

This instrument is subject to directive 2012/19/EC on Waste Electrical and Electronic Equipment (WEEE) and its German national equivalent implemented as the Waste Electrical and Electronic Equipment Act (ElektroG) on the marketing, return and environmentally sound disposal of electrical and electronic equipment. The instrument is a category 9 product (monitoring and control instrument) in accordance with ElektroG (German Waste Electrical and Electronic Equipment Act).



The symbol at the left indicates that this device and its electronic accessories must be disposed of in accordance with applicable legal regulations, and not together with household waste. In order to dispose of the device, bring it to a designated collection point or contact our product support department (☎ 50).

This instrument is also subject to directive 2006/66/EC on batteries and accumulators and waste batteries and accumulators and its German national equivalent implemented as the Battery Act (BattG) on the marketing, return and environmentally sound disposal of batteries and accumulators.



The symbol at the left indicates that batteries and rechargeable batteries must be disposed of in accordance with applicable legal regulations. Batteries and rechargeable batteries may not be disposed of with household waste. In order to dispose of the batteries or rechargeable batteries, remove them from the instrument and bring them to a designated collection point.

Separate disposal and recycling conserves resources and protects our health and the environment.

Current and further information is available on our website at <http://www.gossenmetrawatt.com> under the search terms “WEEE” and “environmental protection”.

© Gossen Metrawatt GmbH

Prepared in Germany • Subject to change, errors excepted • PDF version available on the Internet

All trademarks, registered trademarks, logos, product names, and company names are the property of their respective owners.

 **GOSEN METRAWATT**
Gossen Metrawatt GmbH
Südwestpark 15
90449 Nürnberg • Germany

Phone +49 911 8602-0
Fax +49 911 8602-669
E-mail info@gossenmetrawatt.com
www.gossenmetrawatt.com